

RP1r-Supra / VSN-RP1r+ / ESS-RP1r-Supra Extinguishing Control Panel User Manual

Nota:

This manual is valid for the following control panel models:

- **RP1r-Supra**
- **VSN-RP1r+** (no touch screen)
- **ESS-RP1r-Supra**

To make comprehension easier, when these control panels are mentioned, only the RP1r-Supra model name is used, however, the information is valid for any of the models indicated above.

Contents

1 Introduction	5		
1.1 CE Marking	5		
1.2 System Design and Planning	5		
1.3 Personnel	5		
1.4 General	6		
2 Installation Guide	7		
2.1 Introduction	7		
2.2 Pre-installation Check List	7		
2.3 Transient Protection	7		
2.4 Installation Procedure	8		
2.4.1 Mounting Plate Installation	8		
2.4.2 Panel Enclosure Installation	9		
2.4.3 Installing the Batteries	10		
2.4.4 Enclosure cover	10		
3 Installation	11		
3.1 Cabling Instructions	11		
3.1.1 Cable Terminations	12		
3.1.2 Cable Quality and Installation	12		
3.2 EMC Considerations	13		
3.2.1 Screen Termination	13		
3.2.2 Ferrite Sleeves (Optional)	13		
3.3 Base PCB Wiring Connections	14		
3.4 Input circuits connection	15		
3.4.1 Gas release - Terminal Blocks: A and B	15		
3.4.2 Hold device - Terminal Block: C	16		
3.4.3 Emergency abort device - Terminal block: D	17		
3.4.4 Zone connection - Terminal blocks: E, F and G	18		
3.4.4.1 Call points in zone circuits	19		
3.4.4.2 Gas release call point in zone 3	19		
3.4.5 Technical alarm inputs - terminal blocks: H, I and J	20		
3.4.5.1 Low pressure signal (LOW PRESS) - Terminal block: H	20		
3.4.5.2 Flow signal (FLOW PRESS) - Terminal block: I	20		
3.4.5.3 Door open signal - Terminal block: J	20		
3.4.6 Digital input - Terminal block: K	21		
3.4.7 Input Monitoring	22		
3.4.7.1 Monitoring with an EOL capacitor	22		
3.4.7.2 Monitoring with EOL resistor	23		
3.5 Output circuits connexion	24		
3.5.1 Extinguishing release circuits - Terminal blocks 1 and 2	24		
3.5.2 Auxiliary 24Vdc Output Circuit - Terminal blocks 3 and 4	25		
3.5.3 Sounder circuits - Terminal blocks: 5 and 6	26		
3.5.4 Status relays - Terminal blocks: 7, 8, 9, 10, 11, 12 and 13	27		
3.5.4.1 General fault contact (GEN.FAULT) - Terminal block: 7	27		
3.5.4.2 Status contacts - Terminal blocks: 8, 9 and 10	28		
3.5.4.3 Operating mode contacts: - Terminal blocks: 11, 12 and 13	28		
3.5.5 Output monitoring	29		
3.5.5.1 End of line diode monitoring	29		
3.5.5.2 End of line resistor monitoring	30		
4 Use and operation	31		
4.1 Introduction	31		
4.2 User Interface	31		
4.2.1 LED Status Indicators	32		
4.2.1.1 Front panel: detection process	32		
4.2.1.2 Front panel: Release process	33		
4.2.2 Function keys	34		
4.3 Access levels	35		
4.4 Operating modes	35		
4.5 Control Panel Status	36		
4.5.1 Normal Status	36		
4.5.2 Preactivated status (single zone fire condition)	37		
4.5.3 Activated status (Double zone alarm condition)	38		
4.5.4 Extinguishing release status	40		
4.5.5 End of extinguishing release	41		
4.6 Auxiliary call points	42		
4.6.1 GAS release manual call point	42		
4.6.2 Hold device	42		
4.6.3 Emergency Abort device	43		
4.7 External signals	44		
4.7.1 LOW PRESSURE signal	44		

4.7.2	<i>Flow signal (FLOW PRESS)</i>	45	Appendix A General Wiring Diagram	68
4.7.3	<i>Door open signal</i>	45	Appendix B Specifications	69
4.7.4	<i>Digital input</i>	47	Appendix C Accessories	72
4.8	Disablements	48		
4.8.1	<i>Disable zones</i>	48		
4.8.2	<i>Disable the extinguishing process</i>	49		
4.8.3	<i>Disable the sounders</i>	49		
4.8.4	<i>Silence sounders</i>	49		
4.8.5	<i>Mute Buzzer</i>	50		
4.8.6	<i>Disable external device (only for Belgium)</i>	50		
4.9	Faults	51		
4.9.1	<i>Auxiliary power supply fault</i>	51		
4.9.2	<i>Monitored circuits faults</i>	51		
4.9.3	<i>Sounders Fault / Disabled indicator led</i>	53		
4.10	Other functions	54		
4.10.1	<i>Control panel reset</i>	54		
4.10.2	<i>Evacuation</i>	54		
4.10.3	<i>Leds test</i>	54		
5	Configuration	55		
5.1	Overview	55		
5.2	Configuration mode navigation	55		
5.3	Available options	56		
5.3.1	<i>Extinguishing options</i>	56		
5.3.3	<i>Sounders options</i>	60		
5.3.4	<i>Line options</i>	61		
5.3.5	<i>Additional options</i>	63		
5.4	Special features (UNE-EN54 non-compliant)	64		
5.4.1	<i>Overview</i>	64		
5.4.2	<i>Special functions configuration</i>	64		
5.5	Restore default values	65		
5.6	Monitoring functions	66		
5.6.1	<i>Overview</i>	66		
5.6.2	<i>Access to monitoring functions</i>	66		
5.6.3	<i>Monitored parameters</i>	67		

The material and instructions covered in this manual have been carefully checked for accuracy and are presumed to be correct. However, the manufacturer assumes no responsibility for inaccuracies and reserves the right to modify and revise this document without notice.

1 Introduction

The purpose of this manual is to provide the user with all recommended procedure descriptions and full technical details for the successful installation and commissioning of the extinguishing control panel which is referred to.

Procedures described in this manual include appropriate warnings and cautions to guide the user towards adopting safe and methodical work practices during the installation and commissioning phases.

1.1 CE Marking



This panel is CE Marked to show that it conforms to the requirements of the following European Community Directives:

- Electromagnetic Compatibility Directive 89/336/EEC (and the amendment of the Directives 92/31/EEC, 93/68/EEC).
- Low Voltage Directive 73/23/EEC (and the amendment of the Directive 93/68/EEC).
- The Constructive Products Directive by the application of the following standards:
 - UNE-EN 54-2: Fire detection and fire alarm systems - Control and indicating equipment.
 - UNE-EN 54-4/A2:2006: Fire detection and fire alarm systems - Power supply equipment.
 - UNE-EN 12094-1:2004: Fixed firefighting systems - Components for gas extinguishing systems - Part 1.

1.2 System Design and Planning

It is assumed that the system, of which the Extinguishing control equipment is a part, has been designed by a competent fire alarm system designer in accordance with the requirements of EN54 Part 14 (UNE 23007/14) and other applicable local standards.

The design drawings should clearly show the positions of all the control panel and field devices.

Extinguishing control panels are manufactured in compliance with national and local standards and meet the requirements of UNE-EN 12094-1:2004, UNE-EN 54-2 and UNE-EN 54-4/A2:2006.

However, some installation and configuration practices may not meet the standards. Contact the proper authorities to confirm the requirements.

1.3 Personnel

Installation of this product must be carried out only by suitably-qualified electrical engineers.

Read carefully the commissioning and configuration procedures of this manual. It is recommended by the manufacturer to check the wiring lines before making any connection to the panel or equipment. Do not carry out any configuration functions without fully understanding of their operation.

1.4 General

This release control panel RP1r-Supra has been designed to manage correctly and according to UNE-EN12094-1:2004, UNE-EN 54-2 and UNE-EN 54-4/A2:2006 the automatic release sequence of most of the extinguishing systems.

Moreover, RP1r-Supra meets the following EN12094:1 Options with requirements:

- Delay of extinguishing signal (Section 4.17)
- Signal representing the flow of extinguishing agent (Section 4.18)
- Monitoring of the status of components - Low pressure (Section 4.19)
- Emergency hold device - Sequence b (Section 4.20)
- Control of flooding time (Section 4.21)
- Manual only mode (Section 4.23)
- Triggering of equipment outside the system (Section 4.26)
- Emergency abort device (Section 4.27)
- Activation of alarm devices with different signals (Section 4.30)

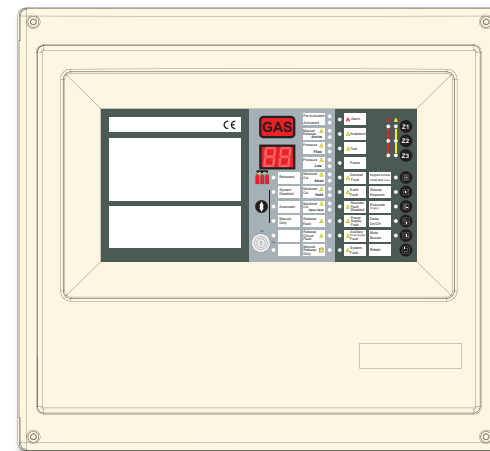

The RP1r-Supra design is based on a modular build concept which offers the user completely flexible system solutions. Each control panel is comprised of a number of separate build modules to simplify the installation process. The electronic components are contained in an easy-to-fit enclosure specifically designed to simplify panel installation. To this end the electronics need not be installed until system commissioning is to be undertaken, thereby reducing the incidence of damage or contamination resulting from other 'trade' activities. (**EasyFix** concept).

RP1r-Supra is a compact control panel which includes a 65W switched power supply with battery charger circuit and it has space provision for two sealed, lead-acid batteries has (2 x 7 Ah) for backup in case of mains loss.

In accordance with UNE-EN 54-4:A2:2006, compulsory standard from August 2009, it is necessary to supervise the internal battery resistance to guarantee the battery correct operation in the event of a power supply fault. The control panel carries regular readings of internal battery resistance to check the resistive value. **If this value exceeds 700 mΩ, the control panel will show a power supply fault**, indicating that the battery status is not correct.

The control panel has 3 input zones for direct connection of 2-wire conventional detectors or external release call points, 2 release monitored circuits and 2 sounder outputs with different frequencies in order to identify each release state.

The control panel also includes different auxiliary inputs and outputs to manage and signal the operating status and different series communication interfaces for optional integration with remote monitoring systems (e.g: TG or Fire.IMT).

According to Section 4.17 of UNE-EN 12094-1:2004, it is possible to specify a delay known as a pre-discharge-warning time which shall be adjustable from 00 and 60 seconds, in 5-second intervals. The front panel provides an informative 2-digit display which indicates the time remaining to start the extinguishing release.

2 Installation Guide

2.1 Introduction

This section is intended to provide you with simple guidelines on how to install the extinguishing control panel quickly and safely.

2.2 Pre-installation Check List

Before installing the extinguishing control panel, you must first ensure that the following criteria have been met. Failure to do this may not only result in damage to the equipment, but may also cause problems when commissioning the equipment or adversely affect its performance.

Before selecting a location for the control panel and devices, DO make sure that:

- The operating room temperature is in the recommended range: -5°C to +40°C
- The relative humidity is between: 5% and 95%
- The panel is wall mounted in a position which allows clear visibility of displays and easy access to operating controls. The height above floor level should be chosen such that the LCD is just above normal eye level (approximately 1.5 metres).
- DO NOT locate the panel where it is exposed to high levels of moisture.
- DO NOT locate the panel where there are high levels of vibration or shock.
- DO NOT site the panel where there would be restricted access to the internal equipment and cabling/wiring connections.

2.3 Transient Protection

This equipment contains transient-protection devices. Although no system is completely immune from lightning transients and interference, for these devices to function correctly, and to reduce susceptibility, this equipment must be earthed correctly.

As with all solid state devices, this system may operate erratically or can be damaged if subjected to lightning-induced transients.

The use of overhead or outside aerial wiring is not recommended due to the increased susceptibility to nearby lightning strikes.

2.4 Installation Procedure

Installation of the RP1r-Supra control panel, in line with **EasyFix** concept, is comprised of two stages: mounting plate installation and panel enclosure installation. Details of each stage are provided in the following sections.

2.4.1 Mounting Plate Installation

To prevent distortion, the RP1r-Supra mounting bracket **MUST** be installed on the wall as flat as possible, i.e. with a maximum flatness deviation between any two points of 3mm. Where the wall is out of tolerance, use appropriate packing pieces to meet these requirements.

Step 1:

- Hold the mounting plate in the required position on the wall and mark the position of the 3 fixing holes. Use a level to ensure these are level.
- Remove the mounting plate from the wall and drill the 3 holes.
- Use rawlplugs or equivalent (\varnothing 6mm) to the 3 holes.

Step 2:

- Screw the mounting plate to the wall, using the top fixing hole only at this stage and appropriately-sized screws.

Step 3:

- Line the 2 holes in the lower area of the mounting plate with the two holes in the wall drilled earlier. Use suitably-sized screws to secure the mounting plate to the wall.

Step 4:

- Remove all blanks from the 20mm cable-entry apertures required for all cable access.

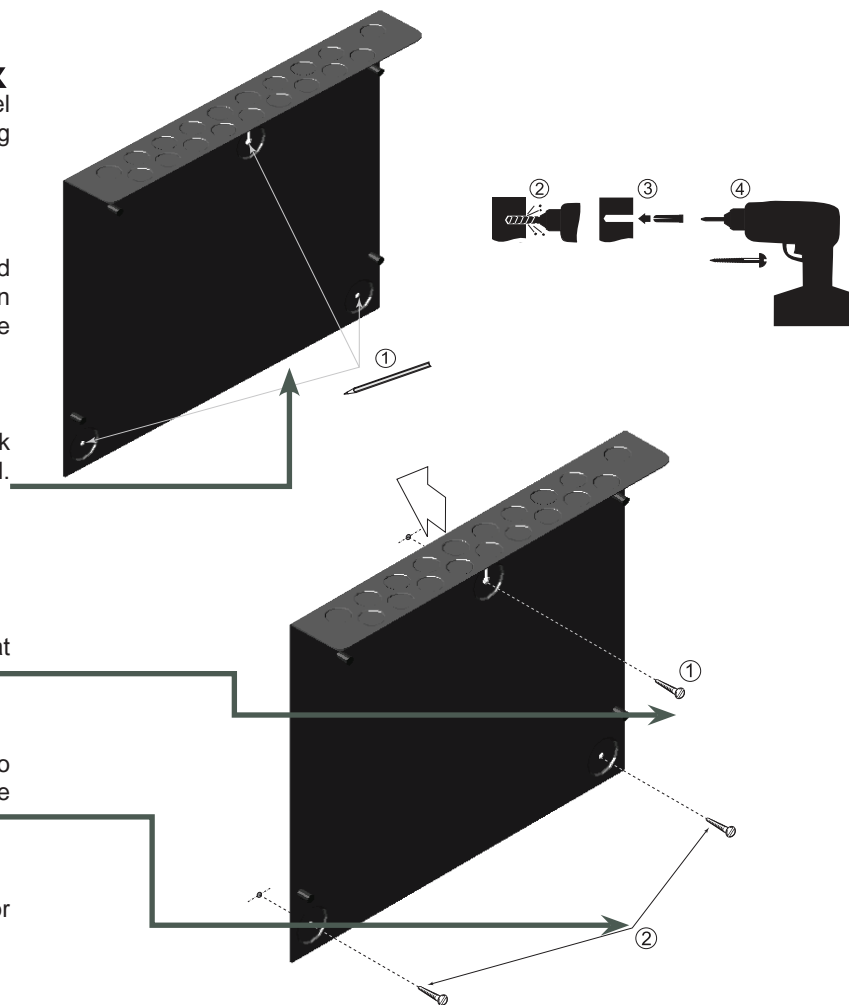

2.4.2 Panel Enclosure Installation

The control panel enclosure is very simple to install providing the mounting plate has been installed correctly as described in Section 2.4.1 Mounting Plate Installation.



This procedure assumes that all field cables have been secured on the mounting bracket with fire industry-approved cable glands, using the appropriate cable apertures (knockouts) and appropriately labelled by function in readiness for termination within the panel.

Step 1:

- With the mounting plate installed on the wall in the desired location, offer the two rebates located at the top of the panel enclosure to engage the enclosure to the mounting plate.
- While performing this procedure, you will need to guide each of the field cables through the aperture located at the back of the enclosure until they are within the enclosure.

Step 2:

- Once the enclosure is aligned correctly with the mounting base, use the 4 suitably-sized screws to fix it.

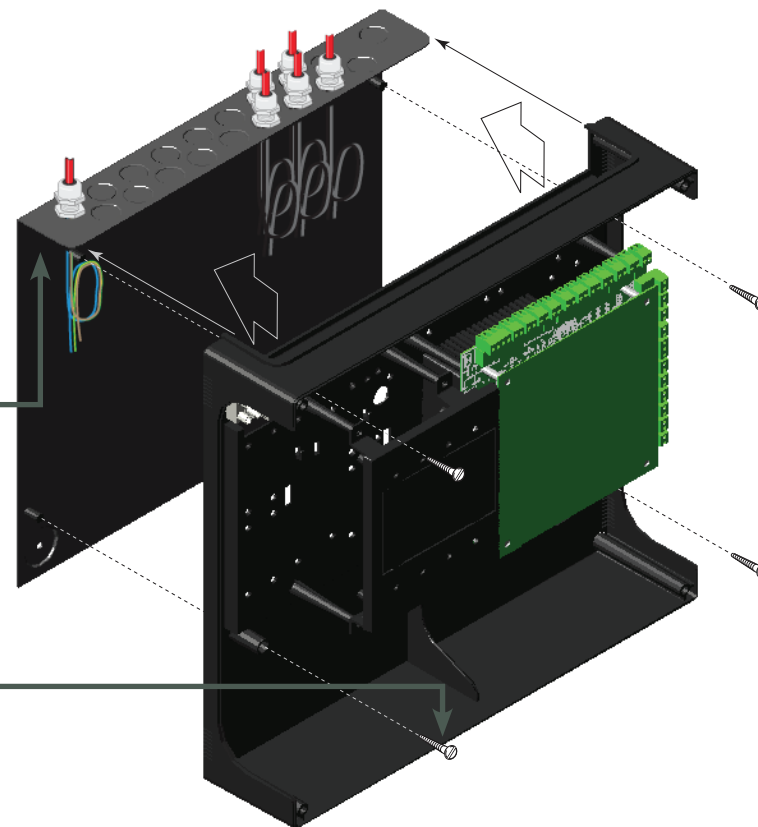



CAUTION - ENERGY HAZARD!
NEVER short the battery terminals.



CAUTION - RISK OF EXPLOSION!
If battery is replaced with an incorrect type.

2.4.3 Installing the Batteries

The batteries must be located in the dedicated space in the lower part of the RP1r-Supra enclosure which has space provision for two 7Ah,12V sealed lead batteries.

- Orientate the batteries so that the wiring connection terminals of each unit are adjacent to each other (as shown opposite) then offer each in turn to the enclosure.
- Locate the batteries in their right position inside the enclosure.

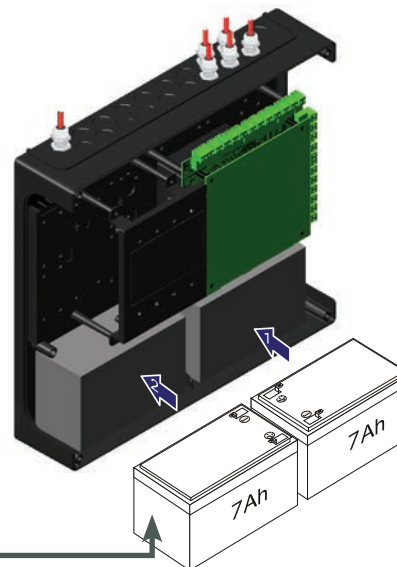

2.4.4 Enclosure cover

The control panel has a cover (door) to close the enclosure at the end of the installation.

Use 4 screws to fix the cover on the enclosure.

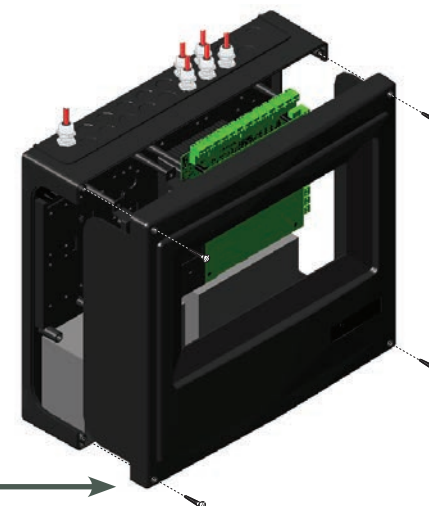

3 Installation

3.1 Cabling Instructions

All wiring should comply with current wiring regulations or the applicable local wiring regulations. Note also the requirements of EN54-14 (UNE 23007/14) for cabling and interconnection of a fire detection and alarm system.

For information on wiring inputs and outputs and wiring instructions to identify terminals, refer to Section 3.3 **External Wiring**.

Use the following rules when installing cables::

1. Cables should be brought into the enclosure using the 20mm cable entry points provided on the top face and back of the enclosure. Ensure that all openings in the enclosure are closed before connecting power to the panel to prevent inadvertent access to hazardous voltages and protect against foreign bodies which may cause short circuits.
2. Tails should be of sufficient length to connect to the appropriate termination points at the commissioning stage.
3. Cable conductor size should be a minimum of 0.5mm². Terminals accept one 0.5 to 2.5mm² stranded or solid conductor.
4. Cables should be screened or metal coated and the screens terminated into the earthing points provided within the enclosure to meet EMC requirements defined by European Directives and to preserve the integrity of the screen connection.
5. Use insulation sleeving on the tails between the cable entry position and the earth post. Run the tails close to the rear wall of the back box.
6. The supply to the panel must be provided with a suitable and readily-accessible, double-pole, mains-disconnect device. The mains supply must be suitably fused and rated according to the specifications.
7. The cable entry points on the extreme left-hand side of the enclosure should be used for mains cable entry. DO NOT route mains cables using any other cable entry points and ensure that the mains wiring is always separated from the low voltage wiring.
8. All low voltage cables should have a minimum 300Vac rating.

3.1.1 Cable Terminations

This section provides guidance on where to bring cables into the enclosure for ease of termination. Ensure the following requirements are met:

1. The mains supply should be brought into the control panel such that the cable path to the PSU is kept as short as possible.
2. All loop and ancillary cable terminations should be brought into the panel enclosure using cable entry points close to their termination points to ensure tails are kept as short as possible
3. Some cable entry points, e.g the nearest to mains entry , should be left unused, where possible, to provide adequate mains supply input/ signal cable segregation.

3.1.2 Cable Quality and Installation

It is vitally important that good quality cable is used, and that correct installation techniques are followed. In general, the following cable installation requirements must be met:

1. All cable sections must be circular to allow effective cable clamping using the cable glands.
2. The cable must be screened (sheathed) to provide protection against Radio Frequency Interference (RFI) and the screen must be connected to earth at the control panel.
3. The screen must be continuous throughout the loop.
4. Cable recommended for use is MICC with a LSF PVC overcovering, a fire resilient cable to BS7629 or PVC/SWA/PVC to BS6387.

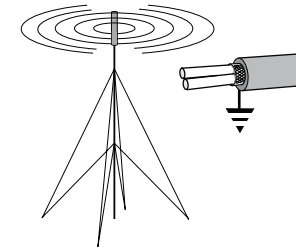
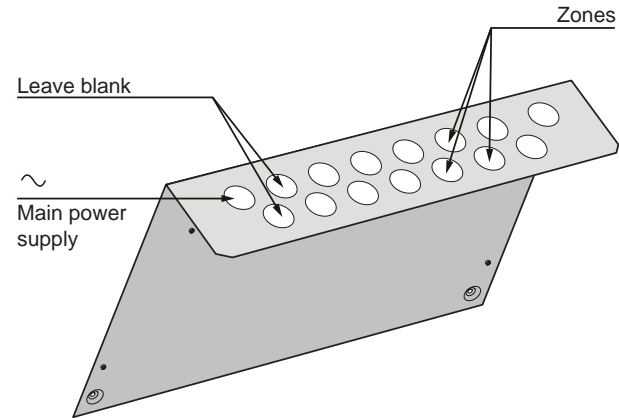

Recommended Cables::

Manufacturer	Product Name	Part Number	Type
Honeywell	2 x 1.5 LHR	2 x 1.5LHR	Fire resistant and halogen free
Honeywell	2 x 2.5 LHR	2 x 2.5 LHR	Fire resistant and halogen free

3.2 EMC Considerations

Following the above instructions and by using suitable cables EMC problems will be avoided. In particularly difficult EMC environments, or where non-preferred cabling is used, it is possible to fit additional ferrite suppressors (sleeves) to cables entering the control panel.

3.2.1 Screen Termination

Cables should be screened or metal coated and the screens must be earthed within the enclosure.

Multiple earthing of cable screens must be avoided. Six earthing points are provided for this purpose, next to the cable entry points, at the rear part of the housing.

Use insulation sleeving on the tails between the cable entry position and the earth post. Run the tails close to the rear part of the back box.

3.2.2 Ferrite Sleeves (Optional)

In difficult EMC environments, or where non-preferred cables are used, optional ferrite sleeves should be fitted to all the wiring entries.

The ferrite sleeves (A) are to be fitted over the conductor(s) of each cable and as close as possible to the entry point of the cable.

The sleeve should be held in place using a cable tie (not supplied).

If more ferrite sleeves are required, please contact your supplier.

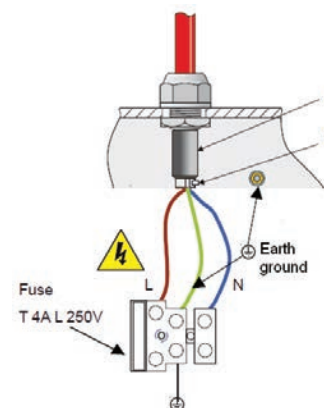
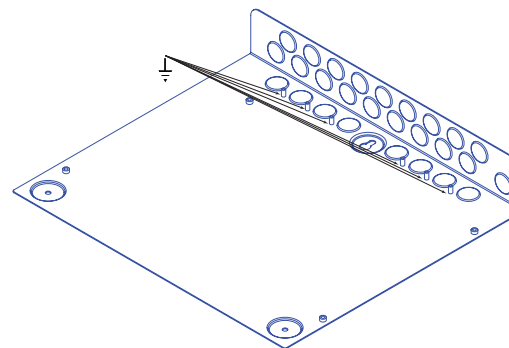

3.3 Base PCB Wiring Connections

The base PCB of the extinguishing control panel provides the external cable/wiring connectors for the following functions.

To recognize the function of connectors easily, the input connections have been identified with alphabetical characters and the output connexions with numbers:

Inputs

- (A) Monitored input for gas release (optional manual call point on front panel).
- (B) Monitored input for gas release (circuit 2)
- (C) Monitored input for hold device (NO)
- (D) Monitored input for extinguishing abort device (NO)
- (E) Monitored input for detectors/call points connexion (Zone 1)
- (F) Monitored input for detectors/call points connexion (Zone 2)
- (G) Monitored input for detectors/call points connexion (Zone 3) or manual call point for gas release.
- (H) Monitored input for low pressure signal (NO)
- (I) Monitored input for flow detection (NO)
- (J) Monitored input for open door detection (NO)
- (K) Digital input for programmable external contact (voltage free)

Outputs

- (1) Monitored output (max. 1A) for release devices solenoid activation (circuit 1)
- (2) Monitored output (max. 1A) for release devices solenoid activation (circuit 2)
- (3) 24Vdc output (250mA). For release devices supply (Resettable)
- (4) 24Vdc output (250mA). For auxiliary devices supply (Fix)
- (5) Monitored output (max. 250mA) for sounders activation (circuit 1)
- (6) Monitored output (max. 250mA) for sounders activation (circuit 2)
- (7) Status relay. General Fault (*)
- (8) Status relay. Extinguishing release activated

- (9) Status relay. Preactivation
- (10) Status relay. Extinguishing release in progress
- (11) Status relay. Extinguishing release cancelled
- (12) Status relay. Manual mode
- (13) Status relay. Automatic mode

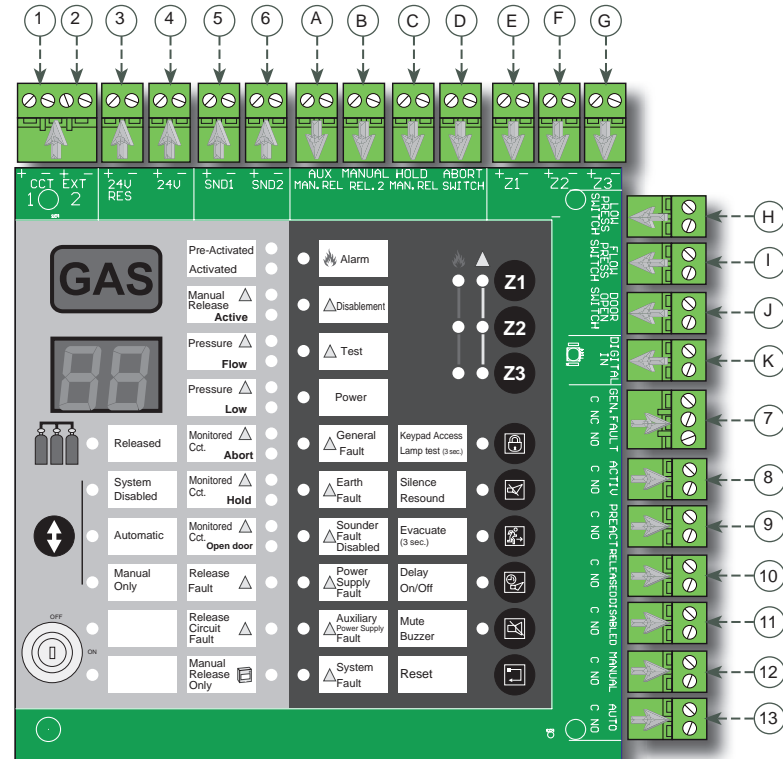

(*) In standby mode (de-energized relays or without power supply) all the status relays have a short circuit between its terminals (C and NO), except the general fault relay (7) which has 3 terminals (C, NO, NC) and allows two status (open circuit: C-NO / closed circuit : C-NC)

3.4 Input circuits connection

This section describes the criteria and requirements for the connection of different circuits and devices whose signals will be used as inputs of the control panel.

3.4.1 Gas release - Terminal Blocks: A and B

If an auxiliary call point (optional) is connected to terminal block “A”, the manual gas release can be activated when the control panel is in Automatic or Manual mode.

When the control panel is in System Disabled mode, the manual call point activation will only activate the sounders circuit (*Preactivated* condition).

A second auxiliary call point can be connected to terminal block “B” in order to activate the release in circuit 2. For this, this function must have been previously activated at the control panel configuration (See Section 5. **Control Panel Configuration** for more details).

To ensure the monitoring, it is necessary to install a serial 2K2 resistor with the call point and a 47µF (≥ 35V) capacitor as an End Of Line element (EOL).

Alternatively, and for compatibility reasons with previous installations, it is possible to replace the capacitor by an **EOL resistor (6K8)**. (See Section 5. **Control Panel Configuration** for more details).

Refer to Section 3.4.7 **Input monitoring** for more information.

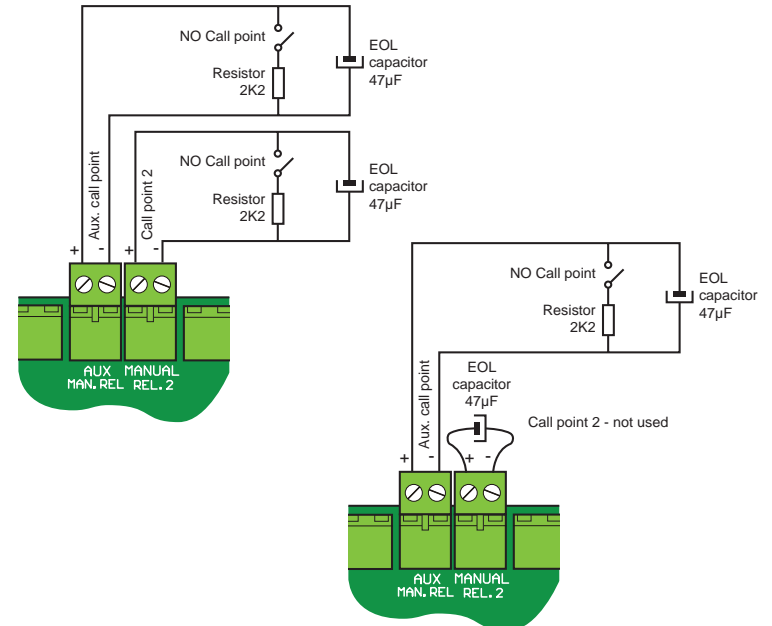
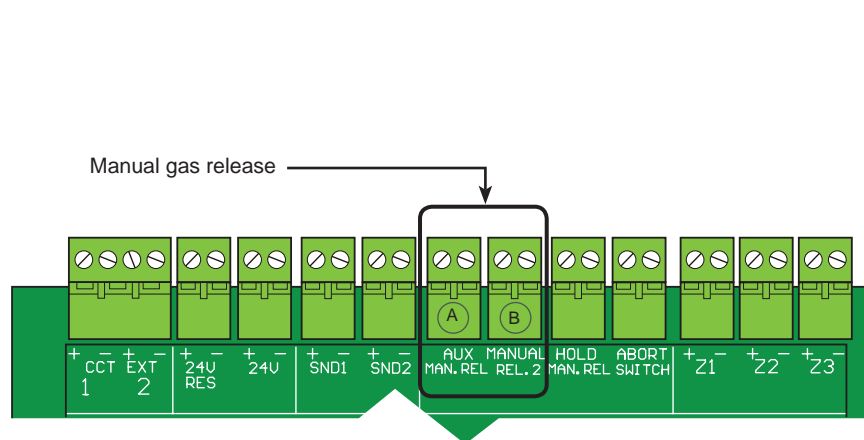

3.4.2 Hold device - Terminal Block: C

The extinguishing control panel has an input for Hold device to comply with the requirements of UNE-EN 12094-1:2004, section 4.20b (Emergency detection devices).

The optional connection of a Hold device to Terminal block “C” allows you to manually stop the automatic extinguishing sequence. While the push button input is active, the countdown timer remains held up and awaiting.

The HOLD input is self-resettable. By releasing the push button, the input is no longer active and the countdown restarts.

To ensure the monitoring, it is necessary to install a serial 2K2 resistor with the call point and a **47µF (≥ 35V)** capacitor as an End Of Line element (EOL).

Alternatively, and for compatibility reasons with previous installations, it is possible to replace the capacitor by an **EOL resistor (6K8)**. (See Section 5. **Control Panel Configuration** for more details).

Refer to Section 3.4.7 **Input monitoring** for more information.

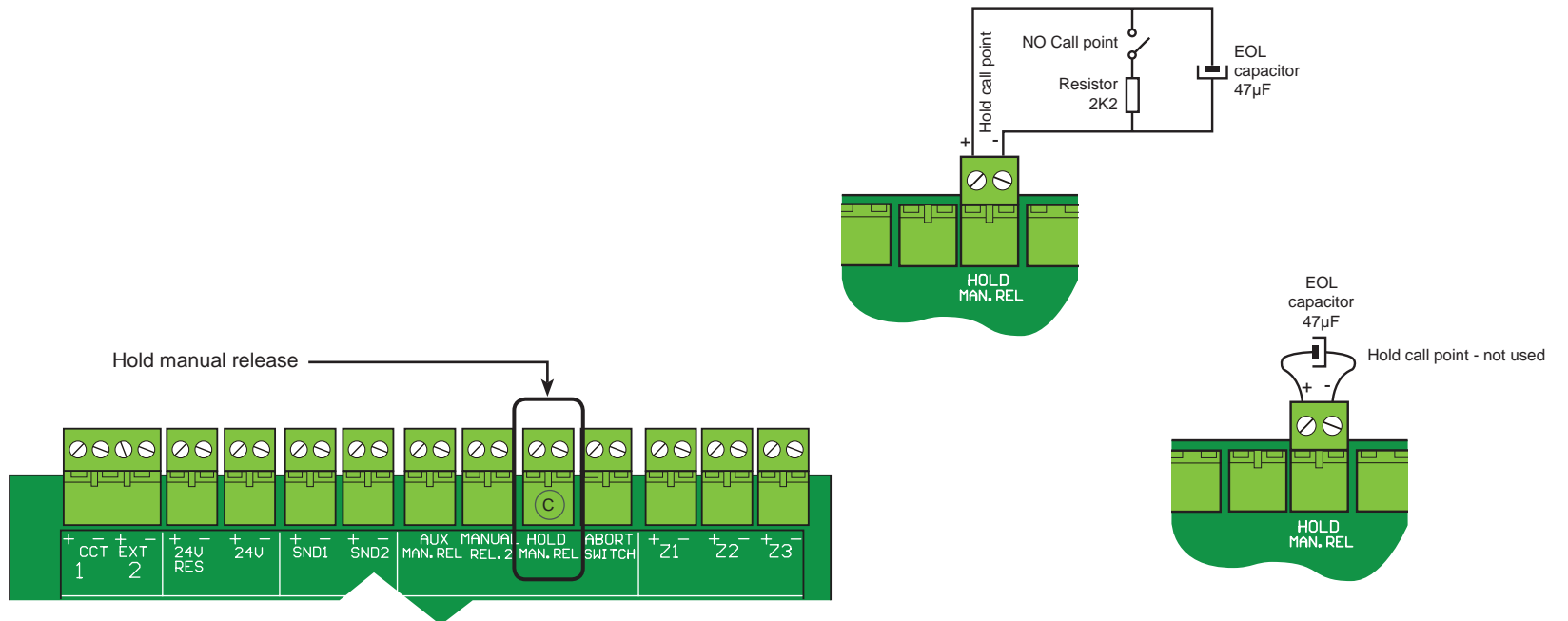

3.4.3 Emergency abort device - Terminal block: D

The extinguishing control panel has an *Abort* input to comply with the requirements of UNE-EN 12094-1:2004, section 4.27 (Devices for emergency abort).

The optional connection of an Abort device to Terminal block “D” allows you to manually stop the automatic extinguishing sequence. The Abort input is latched, so, once activated, it will require a manual reset of the control panel to enable again the extinguishing process.

To ensure the monitoring, it is necessary to install a serial 2K2 resistor with the call point and a 47µF (≥ 35V) capacitor as an End Of Line element (EOL).

Alternatively, and for compatibility reasons with previous installations, it is possible to replace the capacitor by an EOL resistor (6K8). (See Section 5. Control Panel Configuration for more details).

Refer to Section 3.4.7 Input monitoring for more information.

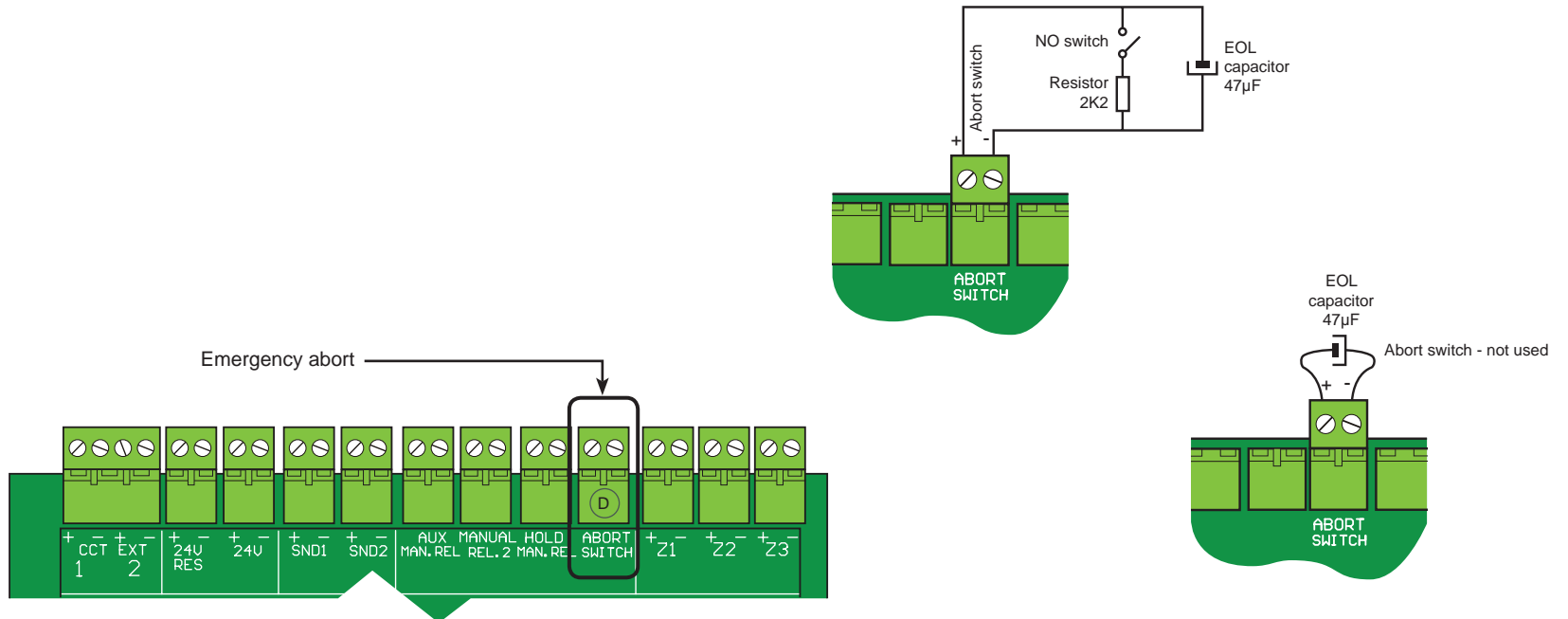

3.4.4 Zone connection - Terminal blocks: E, F and G

The connection terminals for detection zones provide 24Vdc nominal voltage, which is used to supply power to conventional detectors and call points.

When using Notifier series 800 or Morley ECO1000 detectors, up to 32 detectors per zone can be installed.

Detection zone circuits must be wired as a single circuit with no spurs or T junctions to enable the monitoring circuit to work correctly. Moreover, a **47µF (≥ 35V)** capacitor is required as an End Of Line element.

Alternatively, and for compatibility reasons with previous installations, it is possible to replace the capacitor by an **EOL resistor (6K8)**. (See Section 5. **Control Panel Configuration** for more details).

Refer to Section 3.4.7 **Input monitoring** for more information.

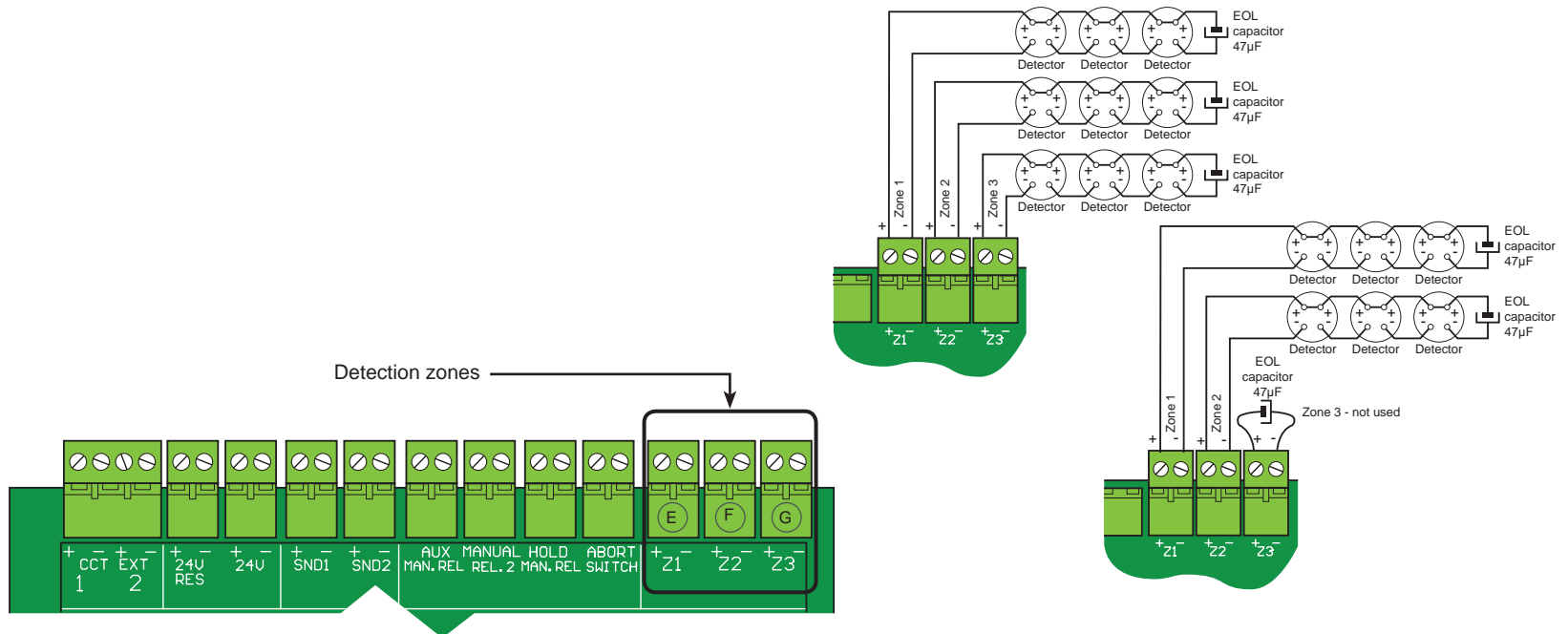

3.4.4.1 Call points in zone circuits

Call points can be included, optionally, in zones 1 and 2.

When it is necessary to distinguish between the indication of a detector alarm and a call point alarm in the same zone, a **5.1V Zener** must be installed in series connection with each of the call points.

Alternatively, it is possible to use a resistor $80\Omega > R > 150\Omega$ in series connection with call points.

The detector alarm will be indicated by the zone led in flashing mode and the call point alarm will be indicated by the zone led in steady mode.

3.4.4.2 Gas release call point in zone 3

If Zone 3 is set as Manual Release zone, it is not necessary to install a 5.1V Zener to indicate call point alarms.

Refer to **Section 5. Control panel configuration** for more information.

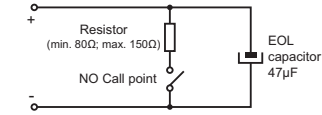
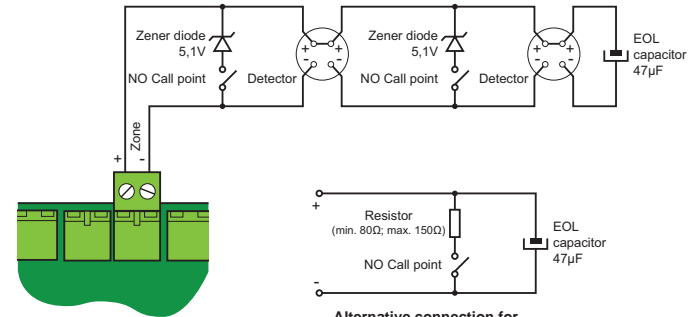

Alternative connection for call point

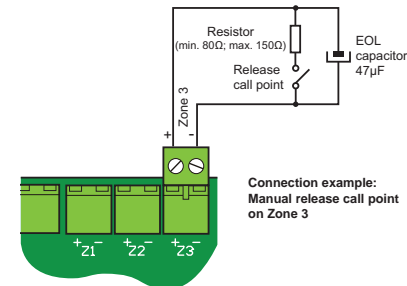

Connection example: Manual release call point on Zone 3

Voltage (%)	0	14	27,5		87	94	100
Status	Shortcircuit	Call point alarm	Detector alarm			Normal (6K8)	Open circuit
Measured resistance	0	-----60Ω 80Ω-----	150Ω 200Ω-----	-----	2K8 3K2- 6K9	>7K8	

Zone status thresholds (approximate values)

3.4.5 Technical alarm inputs - terminal blocks: H, I and J

Using the monitored inputs for external signals available in the control panel, it is possible to detect and signal events from external devices.

To ensure the monitoring, it is necessary to install a serial 2K2 resistor with the corresponding sensor output contact and a **47µF (≥ 35V)** capacitor is required as an End Of Line element or, alternatively, an **EOL resistor (6K8)**. (See Section 5. **Control Panel Configuration** for more details).

Refer to Section 3.4.7 **Input monitoring** for more information.

3.4.5.1 Low pressure signal (LOW PRESS) - Terminal block: H

The low pressure input allows the control panel to signal the status of loss of extinguishing agent in the bottles sent by the sensors installed in the bottles.

3.4.5.2 Flow signal (FLOW PRESS) - Terminal block: I

The control panel has an input that allows the connection of the corresponding flow sensor, which will be monitored, to comply with the requirements of UNE-EN 12094-1:2004, section 4.18 (*Signal flow of extinguishing agent*).

This is a self-resettable input.

3.4.5.3 Door open signal - Terminal block: J

This monitored input indicates the status of the door of the building where the extinguishing system is installed.

The indication is purely informative, however, if the control panel is configured properly, it is possible to condition the automatic extinguishing process, by blocking it when the door is open (see Section 5. Control panel configuration for more details).

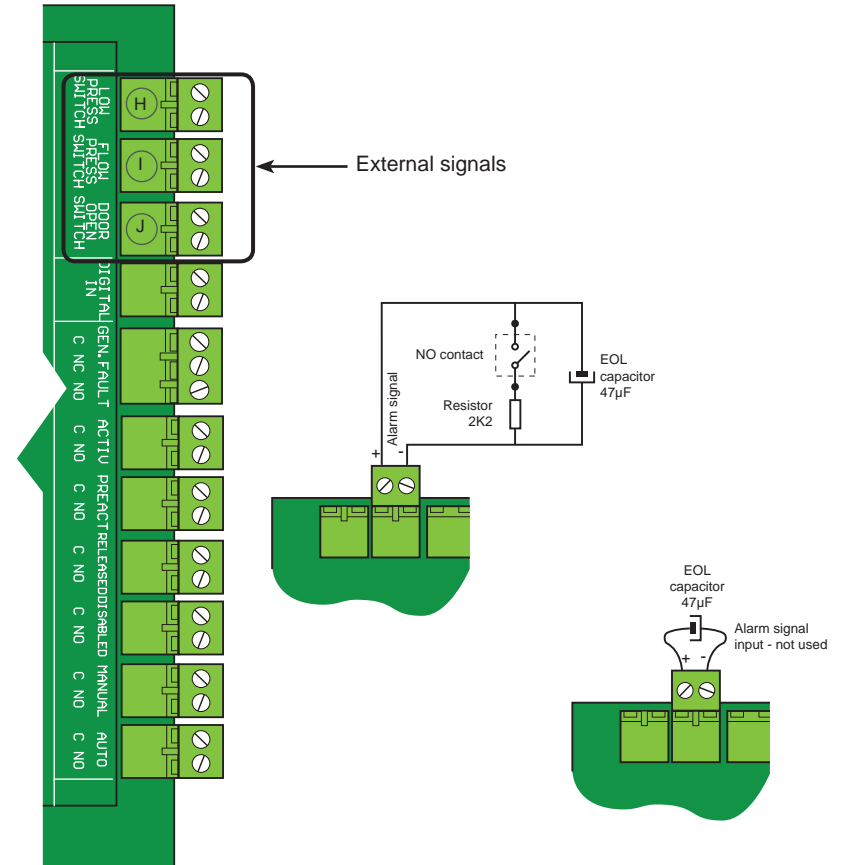

3.4.6 Digital input - Terminal block: K

The extinguishing control panel has a programmable digital input to connect an external contact in order to control the extinguishing control panel from a higher level and external system.

Depending on the control panel configuration, the external contact can be NO (Normally Open) or NC (Normally Closed). Both are voltage free contacts.

There are different functions which can be associated with the activation of this contact, depending on the control panel configuration (see Section 5. Control panel configuration, for more information):

- Reset
- Evacuate
- Mute sounders and buzzer
- Delay on / off

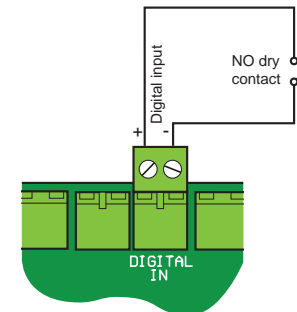
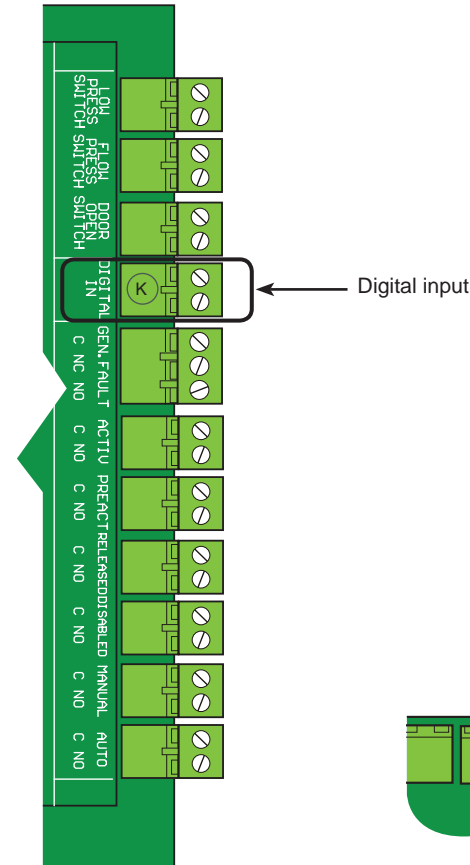

! To avoid irreparable damage to the control panel, do not use contacts or cables with voltage in the digital input.

3.4.7 Input Monitoring

By default, all monitored inputs are **NO** (Normally Open) contacts and they become activated when the circuit is closed with a serial 2K2 resistor.

Monitored outputs may also be used with NC (Normally Closed) contacts which will be activated when the circuit is open. In normal status (standby), the **NC** contact must be connected **in series with a 2K2 resistor**.

The control panel provides two different ways to implement the monitoring circuit by means of an EOL element: with a capacitor (default) or with a resistor.

Refer to Section 5. **Control panel configuration**, for more information).

3.4.7.1 Monitoring with an EOL capacitor

In order to increase the robustness and stability of the monitoring procedure and in compliance with UNE-EN54-13, the control panel uses, by default, an End Of Line capacitor to monitor the input circuits.

To do so, it is necessary to install at the end of each line, a **47µF (≥ 35V)** capacitor.

Moreover, this monitoring procedure reduces the system power consumption and, consequently, the batteries useful life is extended without increasing the battery capacity.

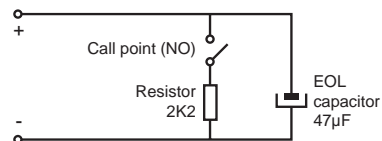

Monitoring topology for NO circuit (capacitive monitoring mode)

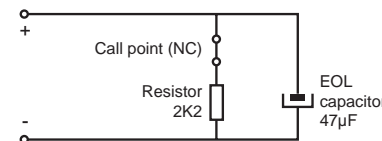

Monitoring topology for NC circuit (capacitive monitoring mode)

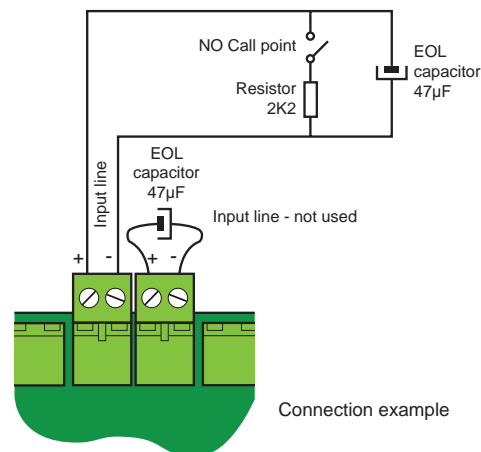

Connection example



In case of using a capacitive end of line mode, the capacitor used as an end of line element in zones will be 47µF (≥ 35V).

The EOL capacitors supplied with the control panel are bipolar type elements, so the polarity of the connection makes no difference.

Using other than the supplied electrolytic capacitors, you must take into account the type of capacitor used and, if necessary, respect the polarity of the connection.

3.4.7.2 Monitoring with EOL resistor

Alternatively, it is possible to use a 6K8 resistor as an End Of Line element for input circuits so that the system is backward compatible with existing installations which use the traditional monitoring EOL resistor.

This monitoring mode is enabled from the control panel configuration. Refer to **Section 5. Control panel configuration** for more details.

The criteria for monitoring and discrimination of the different states by using an EOL resistor (6K8) is as follows:

- For call points with **NO** contacts (default): when the R=2K2 line is closed, the input becomes ACTIVE, regardless of whether the EOL resistor (6K8) is present or not. In the latter case (ACTIVE input without EOL resistor), the control panel will also indicate a fault.
- For call points with **NC** contacts, when the R=2K2 line is open, the input becomes ACTIVE, regardless of whether the EOL resistor (6K8) is present or not. In the latter case (ACTIVE input without EOL resistor), the control panel will also indicate a fault.

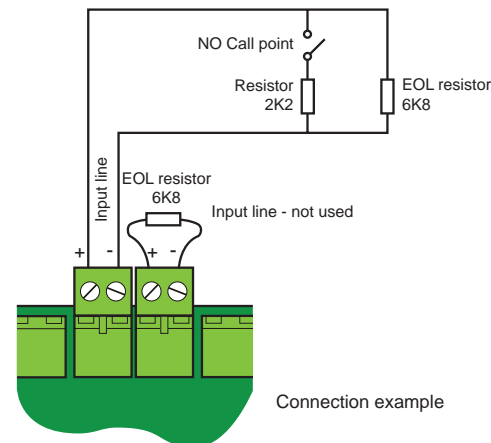
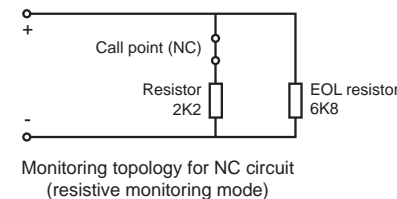
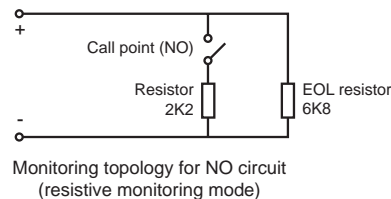

Relative value (%)	0	17,5	28	40	80	100				
Range for NOC	Shortcircuit	Active (2K2 6K8)	Active w/o EOL (only 2K2)	Normal status	Open circuit					
Range for NCC	Shortcircuit	Normal (2K2 6K8)	w/o EOL (only 2K2)	Active (only 6K8)	Open circuit or Active w/o EOL					
Measured resistance	0	370Ω	390Ω	1K8	1K9	3K2	3K3	6K8	23K	>24K

Resistive EOL inputs' threshold for state identification (approximate values)

3.5 Output circuits connexion

This section describes the criteria and requirements for the connection of the external circuits and devices which are monitored by the control panel.

3.5.1 Extinguishing release circuits - Terminal blocks 1 and 2

The outputs of the terminal blocks 1 and 2 will produce the signal to activate the extinguishing release devices solenoids.

Maximum current supplied by each circuit is 1 A (provided that the total sum of intensities supplied by all the control panel outputs do not exceed the power supply limit of 2.4A).

The connection of solenoids depends on the solenoid type and the monitoring method used (see figures on the right).

To ensure the monitoring function, an EOL diode is required or, alternatively, an EOL resistor (6K8). Refer to **Section 3.5.5 Output monitoring** for more details.

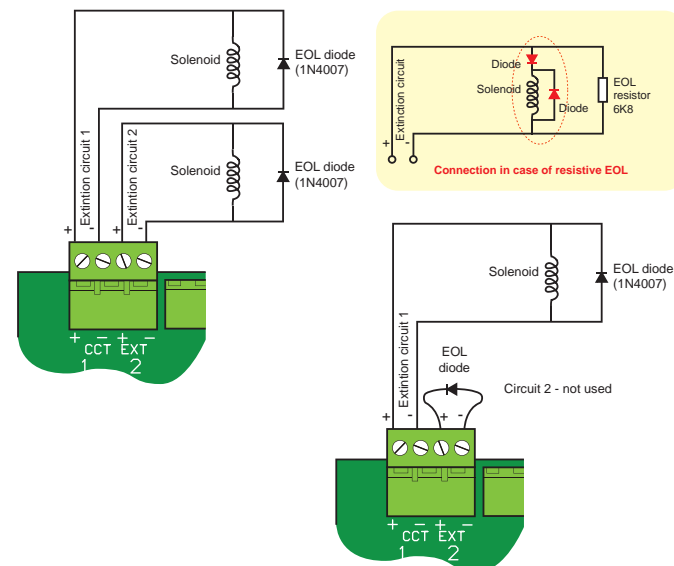



To avoid irreparable damage to the control panel, always use the diode diagram on the right in connections which involve the use of coils (holders, relays, dampers, etc.).

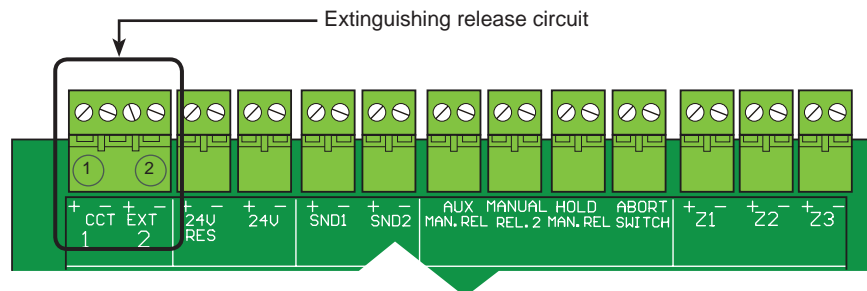

3.5.2 Auxiliary 24Vdc Output Circuit - Terminal blocks 3 and 4

The Base PCB provides two 24Vdc outputs, supplied by the control panel power supply, which can be used to drive ancillary equipment indicators.

Maximum current supplied by each output is 250mA. Both outputs have an over-current protection fuse.

Aux **24V** output (terminal block 4) provides **constant** 24Vdc with $I_{max} = 250 \text{ mA}$ (max. current) to supply ancillary devices.

On the contrary, **24V RES** output (terminal block 3), which is also 24 Vdc and $I_{max} = 250 \text{ mA}$, provides **resettable** supply. Thus, when the control panel is reset, the output voltage goes down to 0V for 5 seconds approximately. This type of output is used to drive external ancillary devices which require a momentarily power cut-off in order to be reset.

Before connecting auxiliary devices to the control panel, please consider the following:

- Ensure that the external wiring is not short circuited.
- Observe correct polarity.
- Before connecting any external circuit to the control panel, check their maximum consumption. To comply with the standards, batteries must be able to keep the system in standby and alarm status for the required periods of time. Ensure that the control panel power supply and batteries provide sufficient capacity. Otherwise, auxiliary devices must not be supplied by the control panel but by suitable external power supplies.



Auxiliary modules with optional connection to the control panel, such as UCIP, VSN-232, VSN-4REL, etc., get their power from non-resettable auxiliary output (block 4), therefore the availability of current I_{max} in this output will be reduced proportionally according to the number and specific consumption of the connected devices.

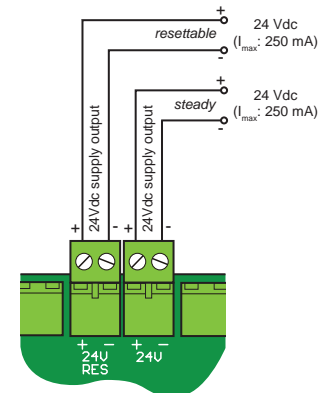
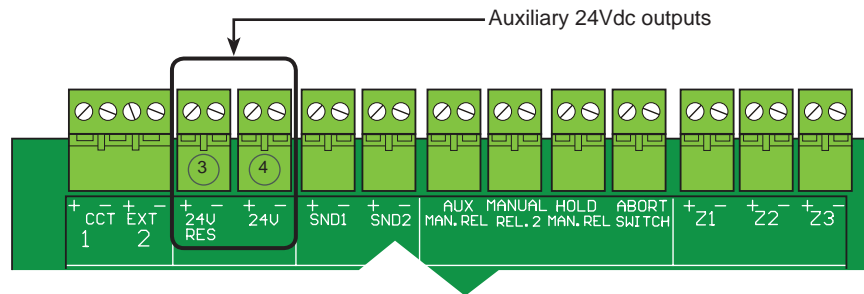

3.5.3 Sounder circuits - Terminal blocks: 5 and 6

The control panel provides two monitored output circuits for sounder activation. The maximum current that each of these circuits can provide is 250 mA. If one of the circuits is not used for sounders, a 68k resistor must be connected between terminals to avoid a fault condition. Alternatively, it is possible to replace this resistor by a reversed polarity diode (see diagram below).

Sounder circuits must be wired as a single circuit with no spurs or T junctions to ensure the correct operation of the monitoring function (see figures below). Moreover, an EOL diode (1N4007 or similar) with reversed polarity (see figure) must be installed after the last sounder.

Alternatively, and for backward compatibility reasons, it is possible to replace the diode by an EOL resistor (6K8). See Section 5. Control panel configuration for more details.

Refer to Section 3.5.5 Output monitoring for more information.

The sounders should be polarized, otherwise a 1N4007 (or similar) diode must be connected to sounder (+) positive terminals to avoid fault conditions.

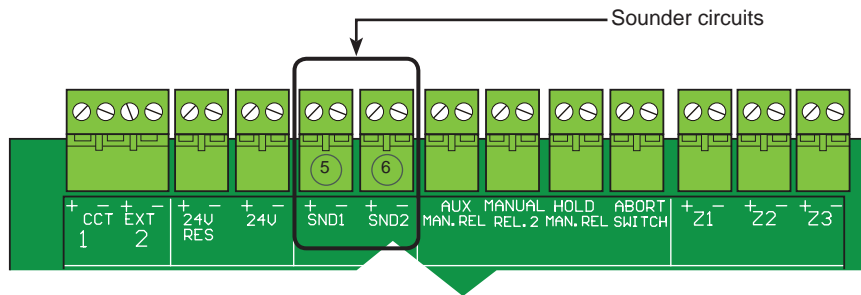
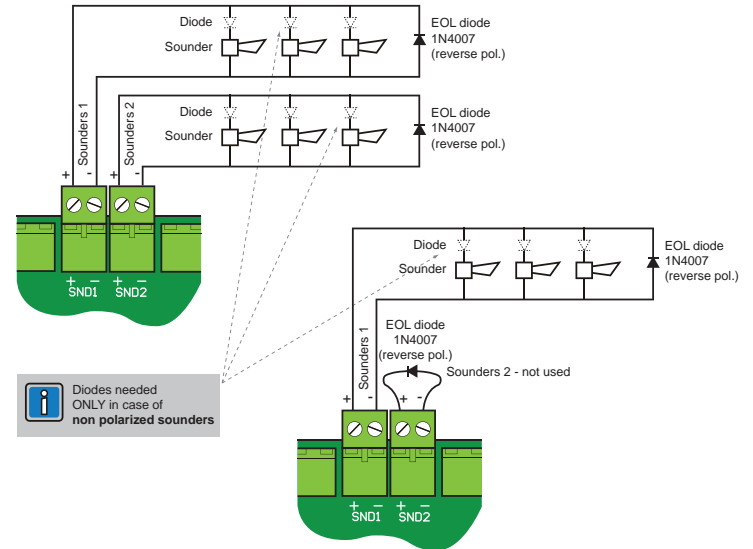

3.5.4 Status relays - Terminal blocks: 7, 8, 9, 10, 11, 12 and 13

The control panel status and operating mode is indicated by means of output relays.

In de-energized mode, all the status relays have a short circuit between its terminals (C and NO), except the general fault relay (7) which has 3 terminals (C, NO, NC) and allows two status (open circuit: C-NO / closed circuit : C-NC)

3.5.4.1 General fault contact (GEN.FAULT) - Terminal block: 7

The general fault relay indicates the existence of a fault condition in the control panel.

In the panel's quiescent status, the relay is energised and when the panel is in a fault condition, the relay is non-energised.

Depending on the control panel configuration, the fault signals can be resettables or latched (refer to **Section 5. Control panel configuration** for more information).

Faults are latched by default and the control panel has to be reset for the relay to return to its normal condition (energised).

On the contrary, the resettable faults make the relay return to its normal condition automatically, when the fault is cleared.

Note: the figure on the right shows the fault condition. The relay is non-energised. In the panel's quiescent status, the relay is energised.

- Quiescent status: Continuity between C and NO contacts
- Fault or without power supply: Continuity between C and NC contacts

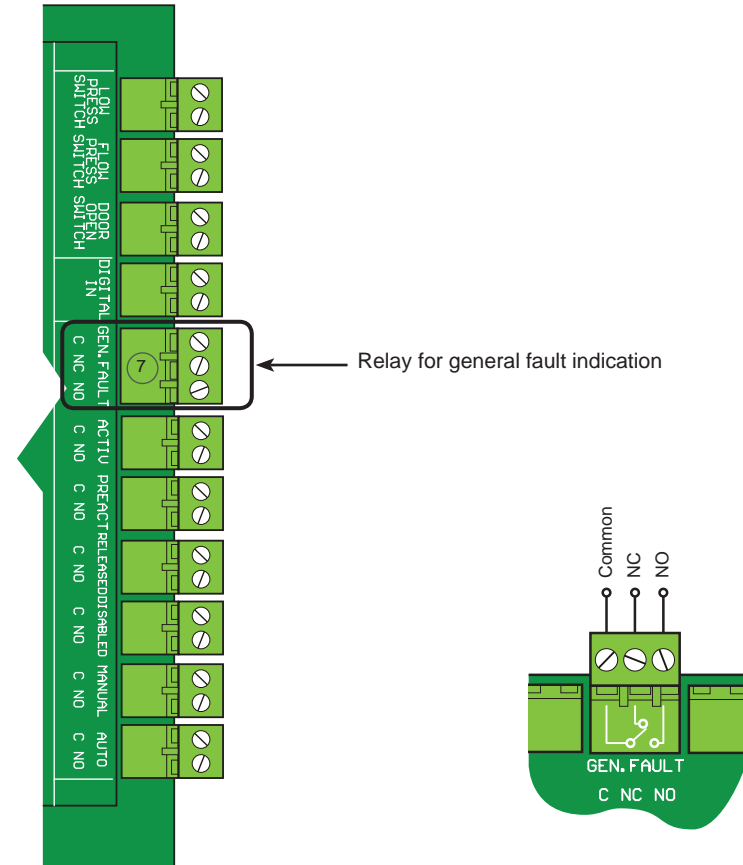

3.5.4.2 Status contacts - Terminal blocks: 8, 9 and 10

The control panel provides 3 output relays to indicate the status of the *extinguishing release process*:

- Activated (terminal block: 8 - ACTIV.)
- Preactivated (terminal block: 9 - PRACT.)
- Release in progress (terminal block 10 - RELEASED)

In standby mode (de-energized), the 3 relays have an open circuit between their terminals (C and NO), as shown in the illustration.

To indicate the control panel status or phase, the corresponding relay is activated. In that situation, the affected relay(s) will show continuity between the terminals C and NO.

3.5.4.3 Operating mode contacts: - Terminal blocks: 11, 12 and 13

The control panel provides 3 output contacts which indicate the control panel status:

- Disabled (terminal block 11)
- Manual (terminal block 11)
- Automatic mode (AUTO) (terminal block 13)

In standby mode (de-energized), the 3 relays have an open circuit between their terminals (C and NO), as shown in the illustration.

To indicate the control panel status, the corresponding relay is activated. In that situation, the affected relay will show a closed contact between the terminals C and NO.

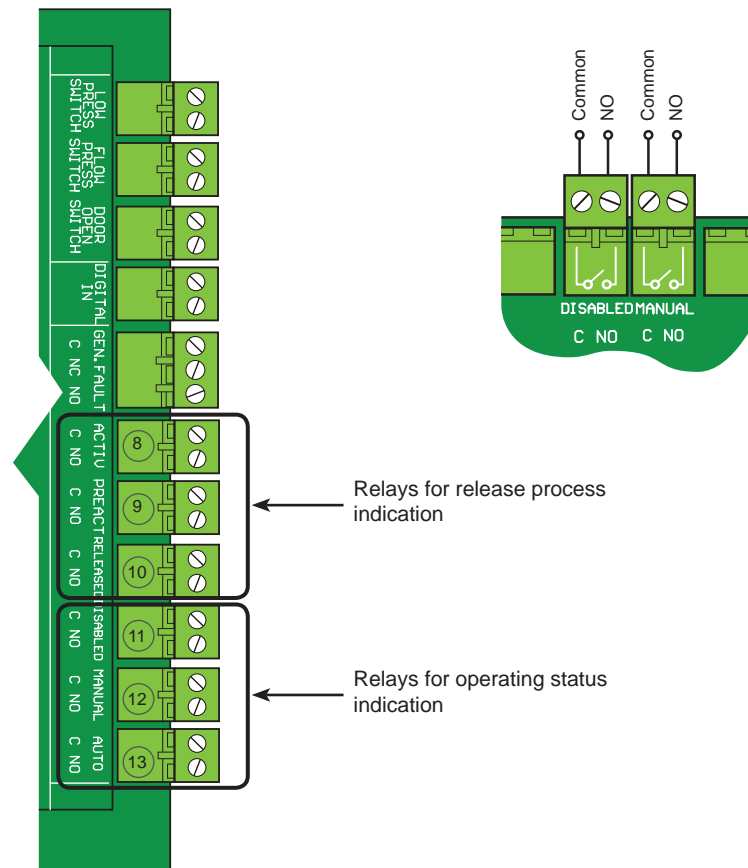

3.5.5 Output monitoring

By default, the control panel's monitored output (terminal blocks: 1, 2, 5 and 6) work based on the detection of a 6k Ω resistive load as end of line element. By configuring the control panel, the monitored outputs can also operate with a polarized diode (see Section 3.4.5.2) as an end of line element. Refer to **Section 5. Control panel configuration** for more details.

3.5.5.1 End of line diode monitoring

In order to increase the robustness and stability of the monitoring procedure and in compliance with UNE-EN54-13, the control panel uses, by default, an End Of Line capacitor to monitor the output circuits. A **reverse polarity diode (1N4007 or similar)** is required (see figure).

This monitoring procedure reduces the system power consumption and, consequently, the batteries useful life is extended without increasing the battery capacity. In addition, diode allows to monitor wiring, determining if this has resistive minimum conditions to guarantee their function.

In this case, and with the outputs in standby status, the control panel injects into the outputs a pulsing signal with inverse polarity and monitors the voltage variation in the output terminals. In activation status, the voltage injection has direct polarity.

- In normal operation (quiescent status), the voltage in the output terminals must be limited by the EOL diode (0.7V approx.). In the absence of this diode, the control panel detects an open circuit and indicates a fault. If there is a short-circuit in the output line or the connected elements are not polarized correctly or even if the wiring resistor was altered and the circuit could not meet its function, the control panel will also indicate a fault (see Section 5.6 Monitoring functions for more information).
- When an output is active, the injected signal has direct polarity. In this case, the reverse polarity of the diode make the current flow through the connected elements (not through the diode) if they are polarized correctly. Otherwise, the control panel will indicate a fault.

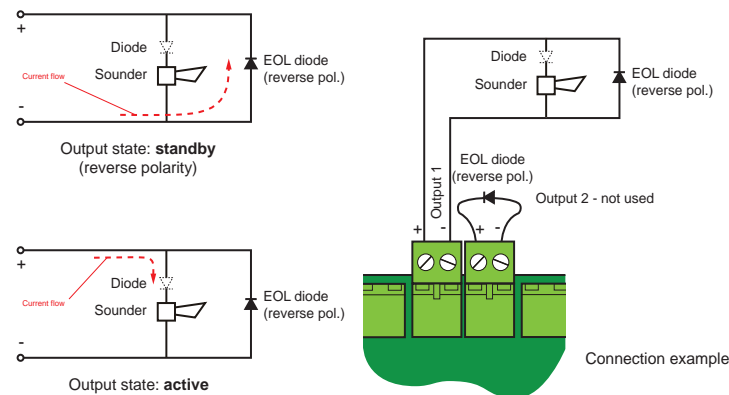

3.5.5.2 End of line resistor monitoring

Alternatively, it is possible to use a 6K8 resistor as an End Of Line element for output circuits so that the system is backward compatible with existing installations which use the traditional monitoring EOL resistor.

This monitoring mode is enabled from the control panel configuration. Refer to **Section 5. Control panel configuration** for more details.

The criteria for output monitoring by means of an EOL resistor (6K8) is as follows:

- In standby operation (quiescent status), the control panel injects into the outputs a reverse polarised signal and monitors the voltage drop caused by the current flow in the EOL resistor (6k8). In the absence of this resistor, there will be no current flow and the control panel will indicate a fault. If there is a short-circuit, the connected elements are not polarized correctly or the resistor value is not the appropriate, the control panel will also indicate a fault.
- When an output is active, the injected signal has direct polarity. In this case, the correct polarity of the connected elements makes the current flow through these elements not through the EOL resistor. Otherwise, the control panel will indicate a fault.

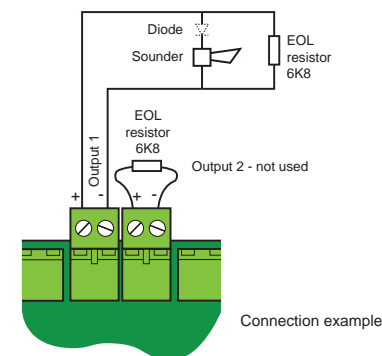
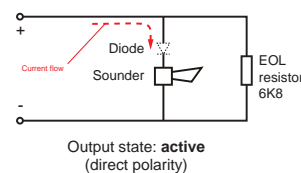
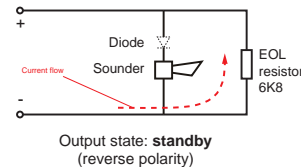

4 Use and operation

4.1 Introduction

This section explains how to use the RP1r-Supra panel's built-in control functions to access various menu functions and/or carry out regular mandatory procedures required by the local regulations. Helpful descriptions and tips are also provided to assist the user in understanding the status information provided by the RP1r-Supra panel's LCD and LED indicators.

4.2 User Interface

The RP1r-Supra control panel is provided with all required indicators to allow the user to review the system status and, with appropriate user access, perform approved system maintenance functions in accordance with the requirements of the local regulations.

System status LEDs are also provided and these divided into two groups

- Indicators for the extinguishing release process.
- Indicators for the monitoring and events or alarms detection.

See **Section 4.2.1 Status leds** for more information.

Function Keys. The user interacts with the information displayed on the panel's LCD using the various function keys. These keys are located on the right side of the front panel.

Entering a valid access Level 2 passcode or using the keyswitch (optional) will make these keys functional. See **Section 4.2.2 Function keys** for more information.

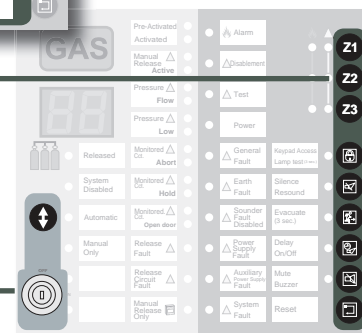
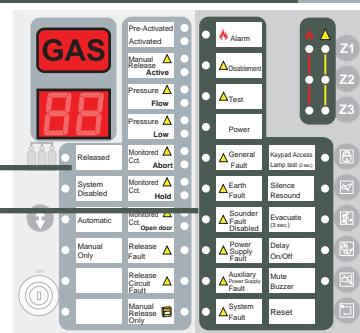
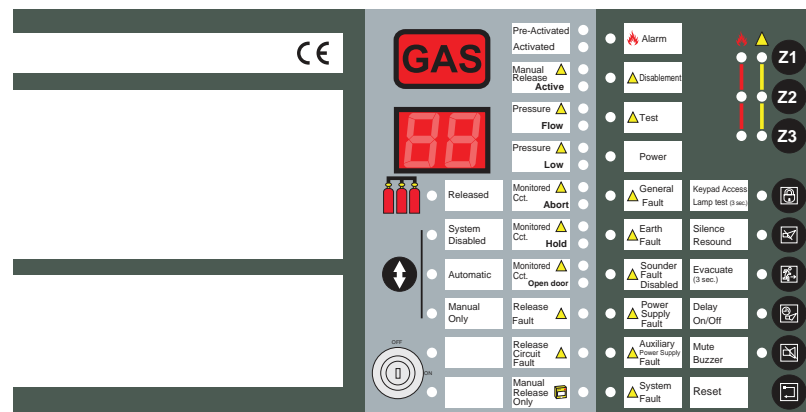

Internal Buzzer. This audible device activates to alert the user to take immediate action whenever the system detects any condition such as a fire or fault event. Depending on the type of event, the buzzer activates (sounds) using a different tone pattern.

The **MUTE BUZZER** control key  is used to silence (mute) the internal buzzer in the event of these conditions occurring.

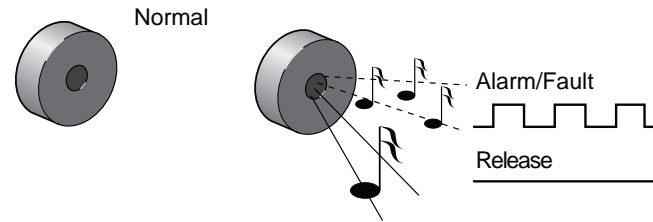

4.2.1 LED Status Indicators

The front panel leds are used to know the system status. All the information, according to the standard requirements, is clearly visualized by means of these leds.

4.2.1.1 Front panel: detection process

The group of leds located on the right side of the front panel are the indicators and keys used for the control panel detection process.

- ① Zone status leds
- ② System alarm led
- ③ Disablement led (disabled zone)
- ④ Test led (zone test)
- ⑤ Power led
- ⑥ General Fault led
- ⑦ Earth Fault led
- ⑧ Sounders Fault/Disabled led
- ⑨ Power Supply Fault led
- ⑩ Auxiliary Power Supply Fault led
- ⑪ System Fault led
- ⑫ Keypad Access led (Access Level 2)
- ⑬ Silence / Resound led
- ⑭ Evacuate led
- ⑮ Delay On/Off led
- ⑯ Mute Buzzer led

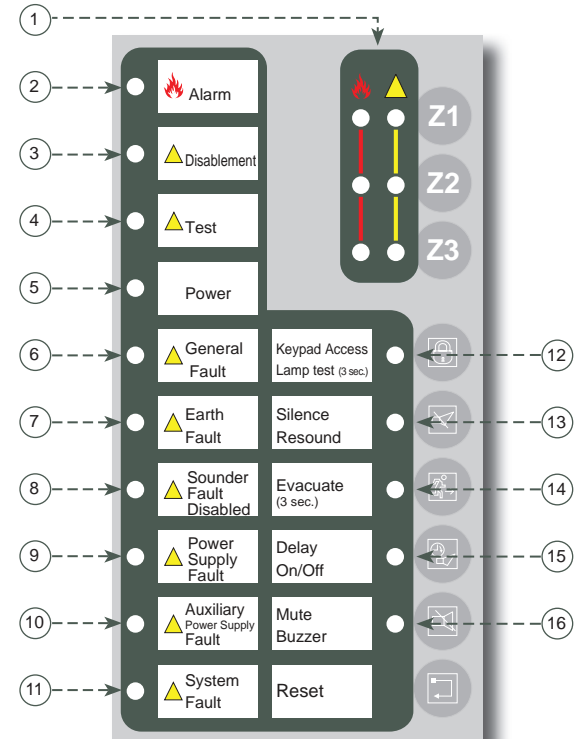

4.2.1.2 Front panel: Release process

The group of leds located on the left side of the front panel are the indicators and keys used for the control panel release process.

- ① Released led (release has started)
- ② Countdown timer for release activation / display for control panel configuration
- ③ Released led (Release is finished)
- ④ Operating Mode leds
- ⑤ Reserved leds for future use
- ⑥ Pre-activated / Activated led (Release status indicator)
- ⑦ Manual Release led
- ⑧ Pressure Flow led (Extinguishing agent flow indicator)
- ⑨ Pressure Low led (Indicator of low pressure due to loss of extinguishing agent)
- ⑩ Monitored Circuit Abort and Hold leds
- ⑪ Monitored Circuit - Open Door led
- ⑫ Release Fault led
- ⑬ Release Circuit Fault led
- ⑭ Manual Release Only led

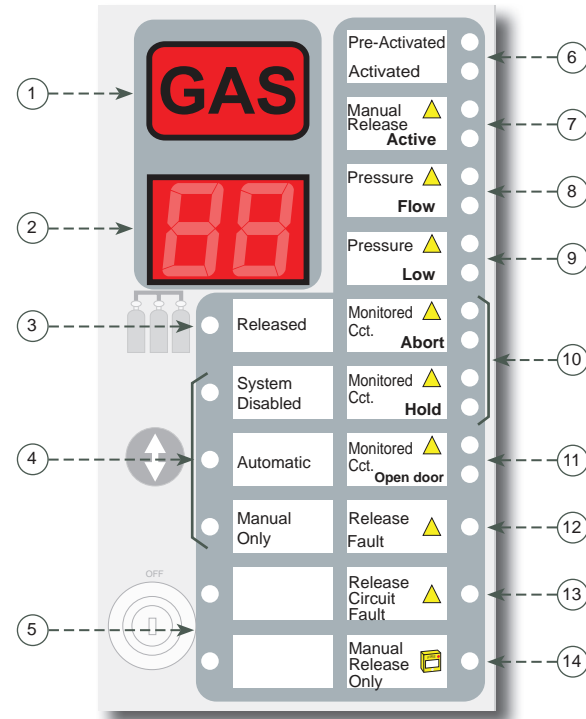

4.2.2 Function keys

Panel operation, at access Levels 1 and 2, is controlled by the various function keys located on the front fascia.

Function control keys are single-function activation keys and, apart from the MUTE BUZZER, require the panel to be at user access Level 2 before they can be selected.

- ① Z1 key to disable/test Zone 1 (access level 2)
- ② Z2 key to disable/test Zone 2 (access level 2)
- ③ Z3 key to disable/test Zone 3 (access level 2)
- ④ Introduction of programming sequences and led test (access level 2)*
- ⑤ Disable/Activate sounders (access level 2)
- ⑥ Manual Activation of Evacuate signal (access level 2)
- ⑦ Activate/Disable the delay before sounders activation (access level 2)
- ⑧ Mute Buzzer (access level 1 - always available)
- ⑨ Control panel Reset (access level 2)
- ⑩ Operating Mode selection (access level 2)**
- ⑪ Key to disable / enable access to keypad (access level 2)



(*) The “Led Test” function of the key (4) is also accessible from level 1.



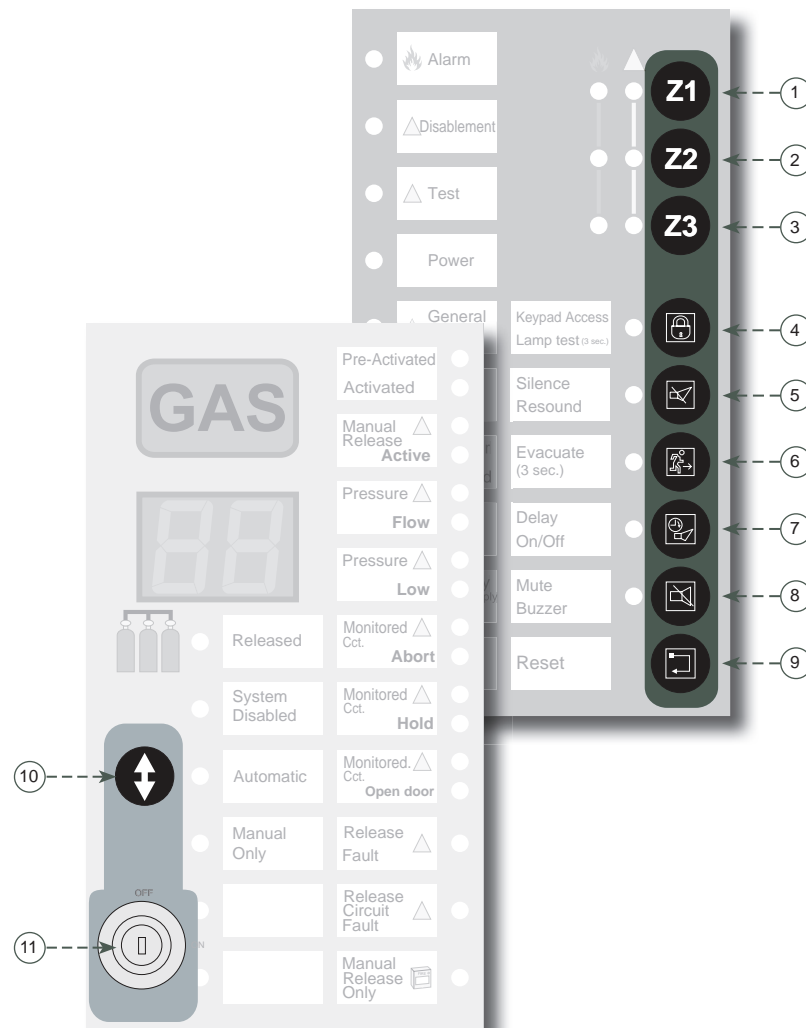

** The button for selecting the mode of operation (10) is only enabled from level 2 if the access to this level is gained through the user key (11).

For security reasons, it is not possible to modify the operating mode if the alternative method for level 2 access (without key, as described in section 4.3.) was used.

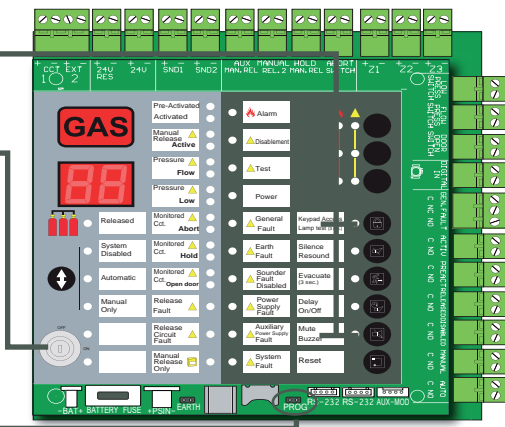

4.3 Access levels

The control panel will enable or disable access to system functions depending on the operating access level.

<p>Level 1</p>	<ul style="list-style-type: none"> Always available with the control panel ON. This level do not require activation. The user is only allowed to mute the internal buzzer and the led test. If any other push button is pressed, the control panel will briefly activate the internal buzzer and its led  	
<p>Level 2</p>	<ul style="list-style-type: none"> Available by turning the key clockwise in order to unlock the keypad. Most of the functions are available (function and zone keys). Keypad access led ON indicates that level 2 is available  Access level 2 (with restrictions) is also gained by means of the following sequence of keys: <ul style="list-style-type: none"> Press and keep pressed the  key. While keeping pressed the  key, press the following keys in this order: Z1, Z2, Z2, Z1 	
<p>Level 3</p>	<ul style="list-style-type: none"> Available by closing the “PROG” jumper located inside the control panel. This access level is used to programme and change the control panel configuration. 	

4.4 Operating modes

The control panel has three operating modes which can be selected with the “mode selector” . The corresponding led is ON when a mode is selected.

The selection of the operating mode can only be carried out from level 2 and only by gaining access by means of the user key

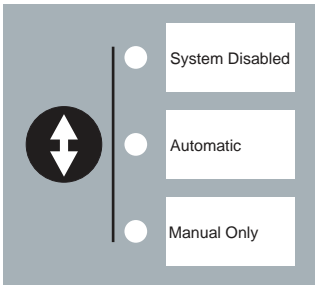
<p>Automatic</p>	<ul style="list-style-type: none"> The control panel manages any alarm from zones or from the gas release call point on the front panel and carries out the release process automatically following the conditions and delays already configured. 	
<p>Manual only</p>	<ul style="list-style-type: none"> The control panel manages any alarm from zones, activating the corresponding conditions and sounders. However, the release can only be activated from the GAS release call point located on the front panel or from the Zone 3 (if it is configured as Manual Release). 	
<p>System Disabled</p>	<ul style="list-style-type: none"> The same as the above condition but it does NOT allow the release outputs to be activated, even manually. 	

4.5 Control Panel Status



For a description of the different status, the control panel is operating in “Automatic” mode. In this situation, the led on the front panel is lit in amber, and the corresponding output contact (AUTO) keeps activated. For any other operating modes, the leds and activated contacts will be those corresponding to the selected mode.

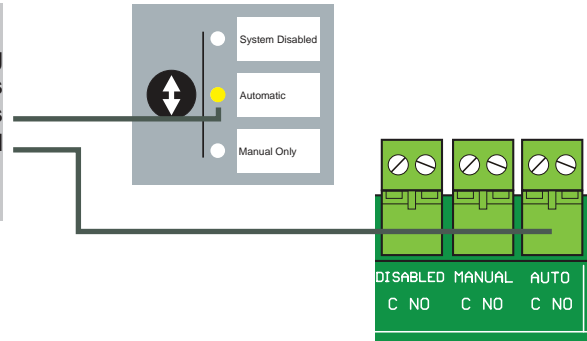



4.5.1 Normal Status

When the panel is at user access Level 1 and also in the quiescent status, i.e. the panel status is normal, the following indications are present:

	<p>POWER LED (green). This is lit continuously when the panel is powered.</p>
	<p>The internal Buzzer is silent.</p>
	<p>GENERAL FAULT relay (GEN.FAULT) energized ≡ standby (continuity between C and NO)</p>

Additionally, the release sequence starts.

According to Section 4.17 of UNE-EN 12094-1:2004, it is possible to specify a delay known as a pre-discharge-warning time which shall be adjustable from 00 and 60 seconds. The configuration of this delay time is restricted to the access level 3 (see **Section 5. Control panel configuration** for more details)

	<p>The GAS sign flashes.</p>
	<p>The countdown begins. By default, the timer shows 60 seconds*.</p>







During the delay time, the sounders cannot be silent.





* When release has been caused by the action of the manual call point, the sequence of extinction begins immediately, without applying the delay set in the parameter **EE**.

It is possible to change this behaviour by default, through the modification of the parameter **Pd** (refer to section 5. Control Panel Configuration for more details).

	<p>The GAS sign lights in steady mode.</p>
	<p>The timer keeps the value 00 seconds in flashing mode.</p>
	<p>The "Released" led flashes.</p>
	<p>Release Circuits: the output relays for solenoid activation of release devices are activated during the period of time already configured (parameter ER , 295 sec., default value)</p>

4.5.5 End of extinguishing release

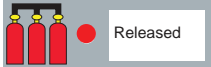
When the release period of time indicated in parameter **ER** is over, the following indications are present:

	<p>The timer keeps the value 00 seconds in steady mode.</p>
	<p>The "Released" led lights in steady mode.</p>
	<p>Release Circuits: the output relays for solenoid activation of release devices are disabled.</p>

4.6 Auxiliary call points

As described in Section 3.4. **Input Circuits Connection**, it is possible to connect a number of auxiliary call points to the control panel to make the remote control easier.

4.6.1 GAS release manual call point

Following the instructions of Section 3.4.1 **Gas release**, it is possible to connect an auxiliary call point (optional) for manual release (only in Automatic or Manual operating modes). The call point activation in this condition will make the control panel go into ACTIVATED status.

According to Section 4.17 of UNE-EN 12094-1:2004, it is possible to specify a delay known as a pre-discharge-warning time which shall be adjustable from 00 and 60 seconds. The configuration of this delay time is restricted to the access level 3, during the control panel configuration process and by means of the parameter **EE** (see **Section 5. Control panel configuration** for more details). The value of this parameter will establish the delay time between the gas release manual call point and the beginning of the release process.

By default, in case of manual call point release, the control panel starts the extinction process immediately, regardless of the value stored in parameter **EE**. If the delay is needed, this option must be activated through the modification of the parameter **Pd** (refer to section 5. **Control panel configuration** for more details).

When the control panel is in Disabled mode, the call point activation will only cause the sounder circuit activation (Preactivated status).



To enable the use of a second auxiliary manual call point, connected to the MANUAL REL.2 input (block B, see section 3.4.1 for more details), it is necessary to previously activate this feature using the parameter **Ep** by accessing control panel configuration mode. In this case, the activation of this second manual call point does not make the control panel enter in Activate status and it only activates extinction circuit 2 (block 2, see section 3.5.1 for more details). The text **Ep** is displayed.

The control panel automatically leaves this status when the condition of manual call point 2 activated disappears.

4.6.2 Hold device

Following the instructions of Section 3.4.2 **Hold device**, and according to the requirements of UNE-EN 12094-1:2004, Section 4.20b (*Emergency detection devices*), the control panel supports (optional) the connection of a hold device which will stop, manually, the automatic release sequence.

If the hold device is activated when the control panel has already started the countdown (Activated mode), the control panel sounders will change from rapid frequency mode to low frequency mode, the countdown stops and the output contact corresponding to “Disabled” mode will activate.

If the Activation has been started from a manual call point, the countdown will only be cancelled if the delay option is activated. This option, which is disabled by default, can be enabled by modifying the parameter **Pd** in the configuration mode (see Section 5. **Configuration** for more details).

The sequence of actions that are implemented by the control panel once the HOLD call point has been activated is the following:

	<p>While the push button input is active, the countdown timer remains held up and awaiting.</p>
	<p>Contact DISABLED: ON</p>
	<p>Sounder outputs (SND1 and SND2) operate in slow pulsing mode (1 Hz)</p>

The HOLD input is self-resettable. By releasing the push button, the input is no longer active and the countdown restarts.

According to UNE-EN 12094-1:2004, section 4.20.4, if there is a fault in the hold device monitoring circuit, **the control panel must indicate the fault condition and avoid the activation of the release circuit.**

It is possible to configure if the Gas release push button input (auxiliary or Zone 3 call point) or has priority over the Hold device by changing the parameter **HL**, during the control panel configuration (refer to Section **5. Control panel configuration**, for more details)

4.6.3 Emergency Abort device

Following the instructions of Section **3.4.3 Emergency Abort device**, and according to the requirements of UNE-EN 12094-1:2004, Section 4.27 (Devices for emergency abort), the control panel supports the connection (optional) of an emergency ABORT device to manually stop the automatic release sequence.

	<p>DISABLED Contact: ON</p>
	<p>Sounder outputs (SND1 and SND2) disabled (silent)</p>

The Abort input is latched, so, once activated, it will require a manual reset of the control panel to enable the extinguishing process again.

As an alternative, and by modifying the parameter **br** (see **Section 5. Configuration** for more details), it is possible to change the default operation of the control panel in front of the activation of the ABORT input, allowing the control panel to keep the abort condition only while the ABORT input is activated. The countdown will be restored automatically once ABORT activated condition disappears. (Note: The modification of this option contravenes the UNE-EN 12094-1:2004 standard).

4.7 External signals





Following the description of Section 3.4.5. **Technical alarm inputs**, the control panel provides a number of monitored input circuits for external signals to detect and signal events from external devices.

4.7.1 LOW PRESSURE signal

The LOW PRESSURE input (LOW PRESS) allows the control panel to signal the status of loss of extinguishing agent in the bottles sent by the sensors installed in the extinguishing agent bottles.

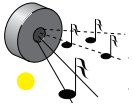
Refer to Section 3.4.5.1 Low Pressure Signal to see the connection of this external signal.





When the control panel receives a low pressure signal, this is considered as a fault. This input is self-resettable.

	<p>The internal buzzer operates (pulsing tone)</p>
	<p>GENERAL FAULT relay (GEN.FAULT) non-energized \equiv fault (continuity between C and NC)</p>
	<p>The ALARM led (red) lights in flashing mode.</p>
	<p>"Low Pressure" led lights in steady mode</p>

- To provide information (default):

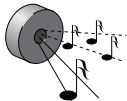
	"Door open" led lights in steady mode
---	--

- To block the extinguishing release process while the door is open. In this situation, the following indications are present:

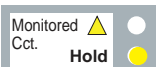
	If the countdown is activated (release in process) and the door is open, the release process goes into Hold mode. When the door is closed, the countdown starts again from the beginning.
	The internal buzzer operates (pulsing tone)
	GENERAL FAULT relay (GEN.FAULT) non-energized \equiv fault (continuity between C and NC)
	The ALARM led (red) lights in flashing mode.
	"Door open" led lights in steady mode
	"Hold" lights in steady mode



If the option 4.26 from EN12094:1/2003 is enabled (see Section 5.4. **Special Functions** for more information), then the **Open Door** led will be used to indicate if the fan output is disabled (led ON) or enabled (led OFF).

4.7.4 *Digital input*

Following the description of Section **3.4.6. Digital input**, the control panel provides a programmable digital input for a free voltage external contact in order to control the panel from any other external system. Refer to Section 3.4.6. for more details.

There are a number of operations which can be carried out when this contact is activated. These operations are determined by the indications of parameter **I.L** , (Refer to Section **5. Control panel configuration** for more details).

4.8 Disablements

4.8.1 Disable zones

Press the required zone key to disable the supervision of one of the 3 detection zones.

This action is only available in **Access Level 2**.

When a zone is disabled, the following indications are present:

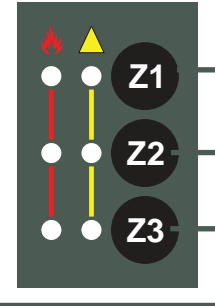

	<p>Disabled zone indicator, lights (yellow).</p>
	<p>"Disablement" led lights</p>

Under these circumstances, the alarms and faults of the disabled zone(s) are not supervised and, in consequence, they will not be indicated at the control panel.

4.8.2 Disable the extinguishing process

To disable the extinguishing process, the control panel has to be set in “Disabled” operating mode by pressing repeatedly the “mode selector”  until the required operating mode led is lit (see Section 4.4. Operating modes). In this operating mode, the extinguishing process cannot be started, manually or automatically.

This function is only available in **Access Level 2**.

The following indications are present:

	<p>“Disabled” led lights</p>
	<p>DISABLED relay: ON</p>

4.8.3 Disable the sounders

According to UNE-EN 12094-1:2004, section 4.15, “Disabling of the transmission path to the alarm devices of a flooding zone shall be possible **ONLY** with the disabling of the transmission path to the actuators of that flooding zone”.

Thus, sounders can only be disabled when the control panel is in “Disabled” operating mode. .

To disable sounders, press the “Silence / Resound” key  from Access Level 2.

When the control panel returns to “Manual” or “Automatic” operating mode, the sounders circuits are automatically restored.

4.8.4 Silence sounders

Unlike the section above (4.8.3 Disable sounders), the active sounders can be silent (not disabled), temporarily, by pressing “Silence / Resound” key  always from **Access Level 2**.

By pressing the “Silence / Resound”  key twice, the sounders sound again.

4.8.5 Mute Buzzer

According to Section 4.3. **Access Levels**, the internal buzzer can be silent from any Access level, even Access level 1, by pressing “Mute buzzer” key.



4.8.6 Disable external device (only for Belgium)

If the option described in UNE-EN 12094-1:2004, section 4.26, is enabled (see Section 5.4. **Special Functions** for more information), the external device linked to the control panel will be disabled or enabled by pressing the “Delay On/Off” key for 3 seconds.



4.9 Faults

4.9.1 Auxiliary power supply fault



According to UNE-EN 54-4:A2:2006, compulsory from August 2009, it is necessary to monitor the batteries internal resistance in order to ensure a correct and safe operation in case of a mains failure. The control panel makes periodic measurements of the battery internal resistance to check the resistive value. **If this value is higher than 700 mΩ, an Auxiliary power supply fault will be generated** to indicate that the state of batteries is not correct.

4.9.2 Monitored circuits faults





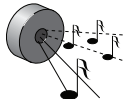

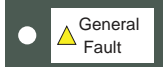

All monitored inputs and outputs require an End Of Line element (EOL) to ensure the monitoring function of the wiring lines (See Section 3. Installation for more details).



If there is a short circuit or the control panel does not detect the EOL resistor, a fault will be generated and the indicator led, on the front panel, will be lit in **flashing** mode. Additionally, the General Fault led and contact will also be activated.

By using the default monitoring mode (capacitive EOL in inputs and diodes in outputs), the control panel also monitors the wiring, determining if it has the resistive minimum conditions to guarantee its function. Otherwise, a fault will be indicated. This additional feature is not present if you are using the monitoring mode by means of a resistive EOL.

	<p>The internal buzzer operates (pulsing tone)</p>
	<p>GENERAL FAULT relay (GEN.FAULT) non-energized ≡ fault (continuity between C and NC)</p>
	<p>The General Fault led lights in flashing mode. (This led ON indicates the presence of any kind of failure in the system)</p>

Depending on the type of fault, the indications are as follows:

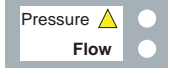
Monitored circuit	Term. Block	Description	Indicator led	Notes	
Release circuit 1	1	CCT EXT 1		"Release circuit fault" led: flashing	Automatic reset option(*)
Release circuit 2	2	CCT EXT 2			
Sounders 1	5	SND 1		"Sounders fault/disabled" led: flashing	Automatic reset option(*)
Sounders 2	6	SND 2			
Manual release	A	AUX. MAN.REL.		"Manual release" fault led: steady	Automatic reset option(*)
Manual release 2	B	MANUAL REL.2		"Manual release" fault led: flashing	Automatic reset option(*)
Hold device	C	HOLD MAN.REL.		"Monitored Cct" led (fault in hold mode): flashing "Hold" led: steady	Automatic reset option(*)
Extinguishing abort call point	D	ABORT SWITCH		"Monitored Cct" led (fault in abort mode): flashing "Abort" led: steady	Aborts release. Manual reset required.
Zone 1	E	Z1		Zone 1 fault led: flashing	Automatic reset option(*)
Zone 2	F	Z2		Zone 2 fault led: flashing	Automatic reset option(*)
Zone 3	G	Z3		Zone 3 fault led: flashing	Automatic reset option(*)

Low Pressure	H	LOW PRESS SWITCH		"Low pressure fault" led: flashing	Automatic reset option(*)
Flow Signal	I	FLOW PRESS SWITCH		"Flow pressure fault" led: flashing	Automatic reset option(*)
Open door	J	DOOR OPEN SWITCH		Monitored Cct - open door led: flashing	Automatic reset option(*)



(*) By default, all faults are latched and require the control panel to be reset in order to be restored.

Except for the abort circuit fault, for the rest of the circuits, it is possible to modify this operation and perform an automatic restore when the fault condition disappears (see Section 5.4 Special functions for more information).

4.9.3 Sounders Fault / Disabled indicator led

There are two possible reasons for the *Sounders fault/disabled* led to be lit:

- If the EOL element has not been installed in any of the 2 sounder circuits (according to Section 3.5.3. **Sounder circuits**, a fault condition will be generated in the monitored circuit. In this case, the "Sounders fault/disabled" led will be lit in **quick flashing** mode (2 Hz). Additionally, the "General fault" led and contact will be also activated.
- According to UNE-EN54 standard, when there is a delay configured for sounders activation, this must be indicated by activating the "Disabled" condition. The "disablement" led lights and the "Sounders fault/disabled" led is also lit, but in this case, in **slow flashing** mode (1 Hz).



When sounders are not still activated, because there is a delay on (through parameter $r.5$), the led of the "Delay ON/OFF"  key will light.

4.10 Other functions

4.10.1 Control panel reset

To perform a reset action, enter a valid user access level 2 passcode and then press the RESET key . (Refer to Section 4.3. Access levels) for more information). This action is used to clear all event indications on the control panel and return it to its normal operation.



On the other hand, according to UNE-EN 12094-1:2004, Section 4.12.2, it is possible to inhibit the reset function temporarily, once the control is ACTIVATED. Use the parameter  to configure the inhibition period of time from the control panel programming mode (See section 5. Control panel configuration, for more details).

4.10.2 Evacuation

To generate an evacuation signal, the control panel must be in quiescent status.

From Access level 2, press and keep pressed the “Silence / Resound” key  for 3 seconds to activate sounders **without activating the release circuits** and generate an evacuation signal.

The following indications are present:

	<p>“Alarm led” lights in steady mode</p>
	<p>Sounders outputs (SND1 and SND2), pulsing signal</p>

4.10.3 Leds test

To perform a led test in order to check that all of them work properly, keep pressed the “Keypad access” key  for 3 seconds, from any Access level (See Section 4.3. Access levels for more information).

The control panel’s LEDs are then lit individually and the internal buzzer sounds.

5 Configuration

5.1 Overview

This panel has different options that allow the modification of its functionalities in order to fit different needs and requirements for each particular application.

These configuration options are only available from **access level 3** (see section 4.3. **Access level**, for additional information).

5.2 Configuration mode navigation

Different parameters and options are displayed on the front user panel 7-segment LCD.

Once access level 3 has been enabled, some of the user keys change their normal function and allow navigation through different configuration options. Enabled keys for this purpose are identified.

	▶	Press this key to select the next parameter
	◀	Press this key to select the previous parameter
	▲	Use this key to increase a value
	▼	Use this key to decrease a value
	SEL/OK	Press this key to confirm the selection or modified value

Note: When moving from one parameter to another, the latest change is saved without pressing SEL/OK.

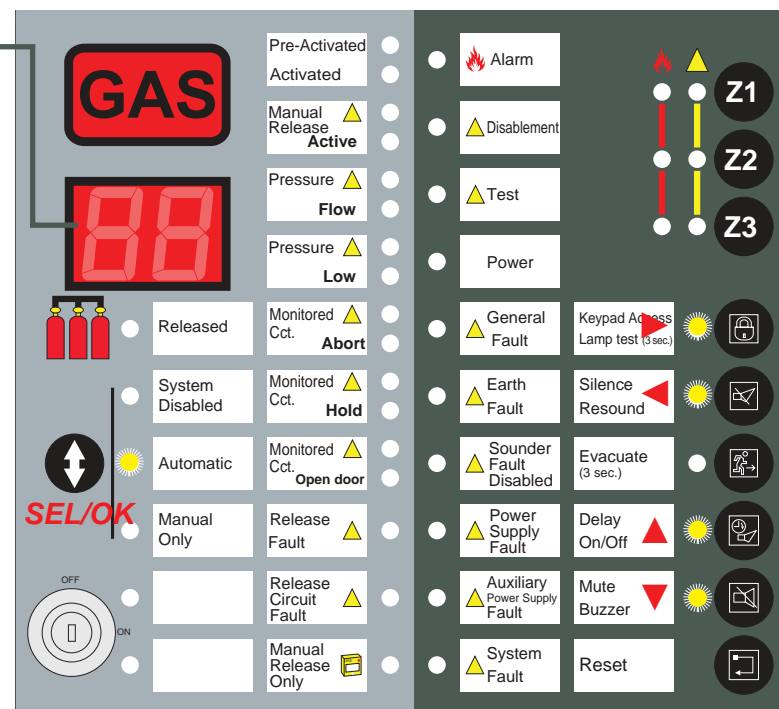

5.3 Available options

5.3.1 Extinguishing options









In order to differentiate if digits displayed on LCD stand for a parameter or a value (Access level 3), a flashing dot between both digits is used in case of a parameter.

	<p>Extinguishing release delay</p>	<p>UNE-EN 12094-1:2004 regulation, section 4.17, describes a delay time before flooding or extinguishing procedure activation called pre-alert or pre-soak time. This time can be modified from 00 to 60 sec., with 5 sec. steps.</p> <p>Delay “t” for extinguishing (default value: 60 sec.)</p> <p style="text-align: center; color: red;">Selectable value from 00 to 60 sec.</p>				
	<p>Soak time for extinguishing circuit 1</p> <div style="border: 1px solid gray; padding: 5px; background-color: #f0f0f0;"> <p> On value introduction mode, dot position is used to calculate total time:</p> <p style="text-align: center;"> = 15 sec. = +100 (115 sec.) = +200 (215 sec.) </p> </div>	<p>According to UNE-EN 12094-1:2004 regulation, section 4.21, there's a soak or flooding time definition for low pressure extinguishing systems.</p> <table border="1" style="width: 100%; border-collapse: collapse;"> <tr> <td style="text-align: center; color: red;">Selectable value from 05 to 295 sec.</td> <td>Time while extinguishing circuit remains active (soak time). (With 5 sec. steps)</td> </tr> <tr> <td style="text-align: center; color: red;">--</td> <td>Circuit remains active until control panel is reset (default option).</td> </tr> </table>	Selectable value from 05 to 295 sec.	Time while extinguishing circuit remains active (soak time). (With 5 sec. steps)	--	Circuit remains active until control panel is reset (default option).
Selectable value from 05 to 295 sec.	Time while extinguishing circuit remains active (soak time). (With 5 sec. steps)					
--	Circuit remains active until control panel is reset (default option).					
	<p>Time delay in case of manual release</p>	<p>In case extinguishing is released by manual call point, it's possible to set the delay time before extinguishing.</p> <table border="1" style="width: 100%; border-collapse: collapse;"> <tr> <td style="text-align: center; color: red;">00</td> <td>Immediate release (default value).</td> </tr> <tr> <td style="text-align: center; color: red;">01</td> <td>Same delay than activated by detection, defined by Et parameter.</td> </tr> </table>	00	Immediate release (default value).	01	Same delay than activated by detection, defined by Et parameter.
00	Immediate release (default value).					
01	Same delay than activated by detection, defined by Et parameter.					



	Release for extinguishing circuit 2	Enable/disable release for extinguishing circuit 2.				
		<table border="1"> <tr> <td>00</td> <td>Disabled (default value)</td> </tr> <tr> <td>01</td> <td>Enabled</td> </tr> </table>	00	Disabled (default value)	01	Enabled
00	Disabled (default value)					
01	Enabled					
	Extinguishing repetition	Enable/disable supervision for FLOW PRESS input to decide if release signal should be repeated.				
		<p>If enabled, and flow press signal remains not active after release, release signal will be repeated up to 3 times. In case of 3 repetitions, the flow press signal remains disabled, control panel will show a fault on extinguishing circuit.</p> <table border="1"> <tr> <td>00</td> <td>Disabled (default value)</td> </tr> <tr> <td>01</td> <td>Enabled</td> </tr> </table>	00	Disabled (default value)	01	Enabled
00	Disabled (default value)					
01	Enabled					
	Hold device priority	Defines if hold device (HOLD input) is prioritized over release device.				
		<table border="1"> <tr> <td>00</td> <td>Release device priority (default value)</td> </tr> <tr> <td>01</td> <td>Hold device priority</td> </tr> </table>	00	Release device priority (default value)	01	Hold device priority
00	Release device priority (default value)					
01	Hold device priority					
	Extinguishing notification	Defines the “extinguishing released” status indication by means of the LED on the front panel.				
		<table border="1"> <tr> <td>00</td> <td>Active LED after E.E delay (default value)</td> </tr> <tr> <td>01</td> <td>Active LED just when LOW PRESS input active</td> </tr> </table>	00	Active LED after E.E delay (default value)	01	Active LED just when LOW PRESS input active
00	Active LED after E.E delay (default value)					
01	Active LED just when LOW PRESS input active					

5.3.2 Zone options













	<p>Zone coincidence condition</p>	<p>Defines the alarm combination to make the control panel change into ACTIVE status and start extinguishing sequence.</p> <table border="1" data-bbox="1001 274 1753 534"> <tr> <td>00</td> <td>Alarm on Z1 & Z2, or Z3 (default value)</td> </tr> <tr> <td>01</td> <td>Alarm on any zone (Z1 or Z2 or Z3), with extinguishing to one zone</td> </tr> <tr> <td>02</td> <td>Any of the following combinations, with extinguishing to two zones: (Z1 & Z2) or (Z1 & Z3) or (Z2 & Z3)</td> </tr> <tr> <td>03</td> <td>Alarm on ALL zones (Z1 & Z2 & Z3)</td> </tr> </table>	00	Alarm on Z1 & Z2, or Z3 (default value)	01	Alarm on any zone (Z1 or Z2 or Z3), with extinguishing to one zone	02	Any of the following combinations, with extinguishing to two zones: (Z1 & Z2) or (Z1 & Z3) or (Z2 & Z3)	03	Alarm on ALL zones (Z1 & Z2 & Z3)
00	Alarm on Z1 & Z2, or Z3 (default value)									
01	Alarm on any zone (Z1 or Z2 or Z3), with extinguishing to one zone									
02	Any of the following combinations, with extinguishing to two zones: (Z1 & Z2) or (Z1 & Z3) or (Z2 & Z3)									
03	Alarm on ALL zones (Z1 & Z2 & Z3)									
	<p>Mode for Zone 3</p>	<p>Defines operating mode for zone 3:</p> <table border="1" data-bbox="1001 599 1753 680"> <tr> <td>00</td> <td>Z3 as a call point (default value)</td> </tr> <tr> <td>01</td> <td>Z3 as a detector</td> </tr> </table>	00	Z3 as a call point (default value)	01	Z3 as a detector				
00	Z3 as a call point (default value)									
01	Z3 as a detector									
	<p>Zone verification</p>	<p>The system provides a period of time for zone alarm confirmation in order to verify if it's real. Enabling this parameter and, in case there is an alarm on any of the three zones, control panel automatically resets the affected zone and waits up to 10 minutes to confirm this alarm. If alarm is repeated on the same zone, this will be notified immediately. Otherwise the timer will be reset after 10 minutes.</p> <table border="1" data-bbox="1001 891 1753 969"> <tr> <td>00</td> <td>Without alarm confirmation (default value)</td> </tr> <tr> <td>01</td> <td>With alarm confirmation</td> </tr> </table>	00	Without alarm confirmation (default value)	01	With alarm confirmation				
00	Without alarm confirmation (default value)									
01	With alarm confirmation									



	<p>Resettable ABORT input</p>  <p>(*) UNE-EN 12094-1:2004 non-compliant</p>	<p>According to UNE-EN 12094-1:2004 regulation, section 4.27, in case that an emergency abort signal is activated (from an external device connected to ABORT input), the extinguishing signal will be inhibited and a manual reset will be required to enable it again.</p> <table border="1" data-bbox="1001 275 1749 354"> <tr> <td>00</td> <td>ABORT input not resettable (default value)</td> </tr> <tr> <td>01</td> <td>ABORT input self-resettable(*)</td> </tr> </table>	00	ABORT input not resettable (default value)	01	ABORT input self-resettable(*)						
00	ABORT input not resettable (default value)											
01	ABORT input self-resettable(*)											
	<p>Open door behaviour</p>	<p>Defines how control panel reacts in case its door is opened.</p> <table border="1" data-bbox="1001 419 1749 529"> <tr> <td>00</td> <td>Just notify "Open door" (default value)</td> </tr> <tr> <td>01</td> <td>Extinguishing procedure locked until door is closed.</td> </tr> </table>	00	Just notify "Open door" (default value)	01	Extinguishing procedure locked until door is closed.						
00	Just notify "Open door" (default value)											
01	Extinguishing procedure locked until door is closed.											
	<p>Operating mode for digital input</p>	<p>Associates a function to DIGITAL IN input:</p> <table border="1" data-bbox="1001 592 1749 790"> <tr> <td>00</td> <td>Remote reset (default value)</td> </tr> <tr> <td>01</td> <td>Evacuate</td> </tr> <tr> <td>02</td> <td>Mute sounders</td> </tr> <tr> <td>03</td> <td>Delay ON/OFF</td> </tr> <tr> <td>04</td> <td>Mute buzzer</td> </tr> </table>	00	Remote reset (default value)	01	Evacuate	02	Mute sounders	03	Delay ON/OFF	04	Mute buzzer
00	Remote reset (default value)											
01	Evacuate											
02	Mute sounders											
03	Delay ON/OFF											
04	Mute buzzer											

5.3.3 Sounders options





	<p>Sounders activation mode</p>	<p>Defines when sounders are activated:</p> <table border="1" data-bbox="1001 243 1749 350"> <tr> <td data-bbox="1001 243 1252 310">00</td> <td data-bbox="1252 243 1749 310">Sounders are activated when PREACTIVE status (default value)</td> </tr> <tr> <td data-bbox="1001 310 1252 350">01</td> <td data-bbox="1252 310 1749 350">Sounders are activated when ACTIVE status</td> </tr> </table>	00	Sounders are activated when PREACTIVE status (default value)	01	Sounders are activated when ACTIVE status
00	Sounders are activated when PREACTIVE status (default value)					
01	Sounders are activated when ACTIVE status					
	<p>Operating mode for sounders 2</p>	<p>Sounders circuit 2 operates, by default, like sounders circuit 1 (flashing mode), and its frequency depends on panel status.</p> <table border="1" data-bbox="1001 444 1749 552"> <tr> <td data-bbox="1001 444 1252 512">00</td> <td data-bbox="1252 444 1749 512">Sounders 2 flashing mode like Sounders 1 (default value)</td> </tr> <tr> <td data-bbox="1001 512 1252 552">01</td> <td data-bbox="1252 512 1749 552">Sounders 2 always activated on steady mode</td> </tr> </table>	00	Sounders 2 flashing mode like Sounders 1 (default value)	01	Sounders 2 always activated on steady mode
00	Sounders 2 flashing mode like Sounders 1 (default value)					
01	Sounders 2 always activated on steady mode					
	<p>Disabled sounders notification</p>	<p>Defines “Disabled sounders” LED status during sounders delay: According to UNE-EN 54-2 regulation, section 9.4.2c, the sounders delay should be indicated as a disconnection.</p> <table border="1" data-bbox="1001 693 1749 801"> <tr> <td data-bbox="1001 693 1252 760">00</td> <td data-bbox="1252 693 1749 760">LED ON during sounders delay (default value)</td> </tr> <tr> <td data-bbox="1001 760 1252 801">01</td> <td data-bbox="1252 760 1749 801">LED OFF during sounders delay</td> </tr> </table>	00	LED ON during sounders delay (default value)	01	LED OFF during sounders delay
00	LED ON during sounders delay (default value)					
01	LED OFF during sounders delay					

5.3.4 Line options

	<p>Short-circuit mode</p> 	<p>Defines how a short-circuit condition for zones should be indicated:</p> <table border="1" data-bbox="991 243 1740 368"> <tr> <td>00</td> <td>Short-circuit notified as a fault (default value) </td> </tr> <tr> <td>01</td> <td>Short-circuit notified as an alarm(*) </td> </tr> </table>	00	Short-circuit notified as a fault (default value) 	01	Short-circuit notified as an alarm(*) 
00	Short-circuit notified as a fault (default value) 					
01	Short-circuit notified as an alarm(*) 					
	<p>Monitoring mode for inputs</p>	<p>It allows choosing End-Of-Line (EOL) device used for inputs monitoring:</p> <table border="1" data-bbox="991 431 1740 512"> <tr> <td>00</td> <td>EOL is a resistor</td> </tr> <tr> <td>01</td> <td>EOL is a capacitor (default value)</td> </tr> </table>	00	EOL is a resistor	01	EOL is a capacitor (default value)
00	EOL is a resistor					
01	EOL is a capacitor (default value)					
	<p>Input mode for HOLD and ABORT signals</p>	<p>It allows choosing operating mode for external devices connected to HOLD and ABORT inputs:</p> <table border="1" data-bbox="991 637 1740 717"> <tr> <td>00</td> <td>Normally open circuit -NO- (default value)</td> </tr> <tr> <td>01</td> <td>Normally closed circuit -NC-</td> </tr> </table>	00	Normally open circuit -NO- (default value)	01	Normally closed circuit -NC-
00	Normally open circuit -NO- (default value)					
01	Normally closed circuit -NC-					
	<p>Input mode for LOW PRESS signal</p>	<p>It allows choosing operating mode for contact connected to LOW PRESS input:</p> <table border="1" data-bbox="991 780 1740 861"> <tr> <td>00</td> <td>Normally open circuit -NO- (default value)</td> </tr> <tr> <td>01</td> <td>Normally closed circuit -NC-</td> </tr> </table>	00	Normally open circuit -NO- (default value)	01	Normally closed circuit -NC-
00	Normally open circuit -NO- (default value)					
01	Normally closed circuit -NC-					
	<p>Input mode for FLOW PRESS signal</p>	<p>It allows choosing operating mode for contact connected to FLOW PRESS input:</p> <table border="1" data-bbox="991 955 1740 1036"> <tr> <td>00</td> <td>Normally open circuit -NO- (default value)</td> </tr> <tr> <td>01</td> <td>Normally closed circuit -NC-</td> </tr> </table>	00	Normally open circuit -NO- (default value)	01	Normally closed circuit -NC-
00	Normally open circuit -NO- (default value)					
01	Normally closed circuit -NC-					

	<p>Input mode for OPEN DOOR signal</p>	<p>It allows choosing operating mode for contact connected to OPEN DOOR input:</p> <table border="1" data-bbox="991 189 1740 266"> <tr> <td data-bbox="991 189 1243 225">00</td> <td data-bbox="1243 189 1740 225">Normally open circuit -NO- (default value)</td> </tr> <tr> <td data-bbox="991 225 1243 266">01</td> <td data-bbox="1243 225 1740 266">Normally closed circuit -NC-</td> </tr> </table>	00	Normally open circuit -NO- (default value)	01	Normally closed circuit -NC-
00	Normally open circuit -NO- (default value)					
01	Normally closed circuit -NC-					
	<p>Input mode for DIGITAL IN signal</p>	<p>It allows choosing operating mode for external contact connected to DIGITAL IN input:</p> <table border="1" data-bbox="991 391 1740 556"> <tr> <td data-bbox="991 391 1243 475">00</td> <td data-bbox="1243 391 1740 475">Normally closed circuit -NC- <i>Input is activated when the contact opens</i></td> </tr> <tr> <td data-bbox="991 475 1243 556">01</td> <td data-bbox="1243 475 1740 556">Normally open circuit -NO- (default value) <i>Input is activated when the contact closes</i></td> </tr> </table>	00	Normally closed circuit -NC- <i>Input is activated when the contact opens</i>	01	Normally open circuit -NO- (default value) <i>Input is activated when the contact closes</i>
00	Normally closed circuit -NC- <i>Input is activated when the contact opens</i>					
01	Normally open circuit -NO- (default value) <i>Input is activated when the contact closes</i>					

5.3.5 Additional options

	<p>Sounders delay</p>	<p>Period of time (in minutes) that elapses between the control panel goes into PREAMBLED status and the sounders are activated. If a single zone alarm is activated, this period of time can be used to check the alarm and reset the control panel before the sounders activation.</p> <p>Time delay until sounders activation (default value 00 min.)</p> <p style="color: red;">Selectable value from 00 to 10 minutes</p>						
	<p>Reset disabled after release</p>	<p>According to UNE-EN 12094-1:2004, section 4.12.2, there must be a configurable time gap, from 0 to 30 minutes, since ACTIVE status is notified and reset is allowed.</p> <table border="1" data-bbox="999 514 1747 719"> <tr> <td style="text-align: center;">--</td> <td>Reset remains disabled until released is finished or until the time configured in parameter EA ends (EA → 0 seg.)</td> </tr> <tr> <td style="text-align: center;">00</td> <td>Allowed reset at any time (default value)</td> </tr> <tr> <td style="text-align: center;">De 01 a 30</td> <td>Reset remains disabled during configured time (minutes)</td> </tr> </table>	--	Reset remains disabled until released is finished or until the time configured in parameter EA ends (EA → 0 seg.)	00	Allowed reset at any time (default value)	De 01 a 30	Reset remains disabled during configured time (minutes)
--	Reset remains disabled until released is finished or until the time configured in parameter EA ends (EA → 0 seg.)							
00	Allowed reset at any time (default value)							
De 01 a 30	Reset remains disabled during configured time (minutes)							
	<p>Earth fault level</p>	<p>Defines the threshold level to detect an earth fault:</p> <table border="1" data-bbox="999 817 1747 938"> <tr> <td style="text-align: center;">00</td> <td>Low Sensitivity</td> </tr> <tr> <td style="text-align: center;">01</td> <td>Medium</td> </tr> <tr> <td style="text-align: center;">02</td> <td>High Sensitivity</td> </tr> </table>	00	Low Sensitivity	01	Medium	02	High Sensitivity
00	Low Sensitivity							
01	Medium							
02	High Sensitivity							
	<p>Monitoring mode for outputs</p>	<p>It allows choosing End-Of-Line (EOL) device used for outputs monitoring:</p> <table border="1" data-bbox="999 1001 1747 1081"> <tr> <td style="text-align: center;">00</td> <td>EOL is a resistor</td> </tr> <tr> <td style="text-align: center;">01</td> <td>EOL is a diode (default value)</td> </tr> </table>	00	EOL is a resistor	01	EOL is a diode (default value)		
00	EOL is a resistor							
01	EOL is a diode (default value)							

5.4 Special features (UNE-EN54 non-compliant)

5.4.1 Overview

This control panel allows special configurations for resettable faults, single 24V operation for naval sites or powered from UPS, or single 220Vac operation as a dependant subsystem. These configurations do not meet UNE-EN 54-4/A2:2006 or UNE-EN 54-2 requirements and are only used for special operations.

5.4.2 Special functions configuration

In order to modify any of the special features, the following procedure should be followed:

- Switch off the control panel (main supply and batteries).
- Change control panel into **level 3** by closing jumper “PROG” (see section 4.3 Access level, for additional information).
- Switch on the panel again.
- After a few seconds, almost all LEDs will turn off and only LEDs associated to special functions will remain turned on, showing the current status for special configuration (see table). The “System fault” LED will be flashing .
- Press the key(s) associated to special features to be modified (see table). The LED will change its status showing the modification on the associated function.

(*) UNE-EN 12094-1:2004 non-compliant









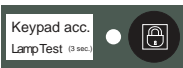

Special setup only for configurations where EN-12094-1:2014 is not applicable. If this setup is selected, the CE labeling related to this standard has to be removed from the equipment.



(*) This kind of configurations are not compliant with UNE-EN54-4/A2:2006 and UNE-EN 54-2 regulations. They are only available for special cases and must be used in agreement with the appropriate authority.

If this setup is selected, the CE labeling related to this standard has to be removed from the equipment.

	On	Latched faults. Faults need to be RESET by the control panel (<i>default</i>)
	Off	Resettable faults. Faults are self-resettables once the fault cause has disappeared.
	On	Main power supply faults are indicated (<i>default</i>)
	Off	Main power supply faults are not indicated (*)
	On	Battery faults are indicated (<i>default</i>)
	Off	Battery faults are not indicated (*)
	On	Sounders will re-activate after a new alarm (<i>default</i>)
	Off	Sounder will not re-activate after a new alarm (*)
	On	VSN4-REL module installed
	Off	No VSN4-REL module installed (<i>default</i>)
	Reserved	A number of special configuration profiles can be selected with special functions (non-standard). The selected profile is identified on the 7 segment display (standard profile by default).
	On	Communication faults are indicated (for communication channel monitoring with graphic software TG-RP1r).
	Off	Communication faults are not indicated (<i>default</i>)
 Selection by means of user key	On	Low battery sensitivity (*). Threshold for monitoring the battery inner resistor. <i>The threshold selection is done by modifying the position of the user key to gain access to the keypad. Only one change at a time.</i>
	Off	High battery sensitivity (<i>default</i>)

5.5 Restore default values

In order to restore the default values for configuration parameters, the following procedure must be followed:

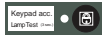
- Change control panel into **level 3** by closing jumper “PROG” (see section **4.3 Access level**, for additional information).
- Press and hold, “Keypad access” key .
- While keeping pressed “Keypad access” key , press the following sequence of keys: Z1 - Z2 - Z2 - Z1.

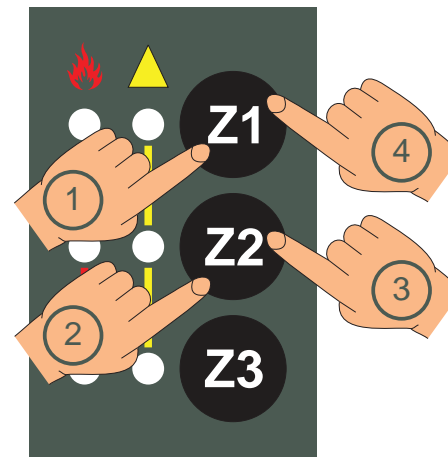

Key combination to restore configuration default values



This option is only available at access level 3.



This action only restores the default values corresponding to the configurable options. Special functions accessible from level 3 (see Section 5.4 Special Functions) do not recover the factory-defined configuration and, if necessary, they must be restored manually using the corresponding procedure.

5.6 Monitoring functions

5.6.1 Overview

The monitoring technique using a diode or capacitor as an end of line (EOL) element, as opposed to the traditional method of supervision through resistive EOL, allows the control panel to monitor the wiring by determining if this has resistive minimum conditions to guarantee its function.

That is, if one of the wiring lines (e.g. extinguishing circuit) has an excessive resistance along the length or quality of the cable (e.g. 4 Ω), with 1A of current, this would mean a voltage drop of 4V, which could result in that the solenoid valve associated to that circuit could not be activated.



Classic monitoring method, using EOL resistive element, only determines the status of a line in relation to short circuits or open circuits, so the previous case had not been detected. With the technique used in RP1r-Supra, using diodes and capacitors as end of line elements, it is possible to determine the resistance of the line and to be aware of hypothetical faults in the wiring.

Values which emerge from the supervision of the different circuits can be monitored and visualized at the control panel.

These monitoring functions are only accessible from access level 3 (see **Section 4.3. Access Levels**, for more information).

5.6.2 Access to monitoring functions

The following procedure must be followed in order to access to monitoring functions:

- Gain Access Level 3 by closing jumper “PROG” (see Section 4.3. **Access Levels**, for more information).
- Press “Evacuation”  key to enter Monitoring mode.
- “Evacuation” led flashes and the corresponding keys light up to be identified.
- Parameters and associated values are displayed on the front panel.
- Navigate through the different options by means of these keys: “Keypad”  and “Silence Resound” .
- Press the “Evacuation” key again to leave the Monitoring mode.

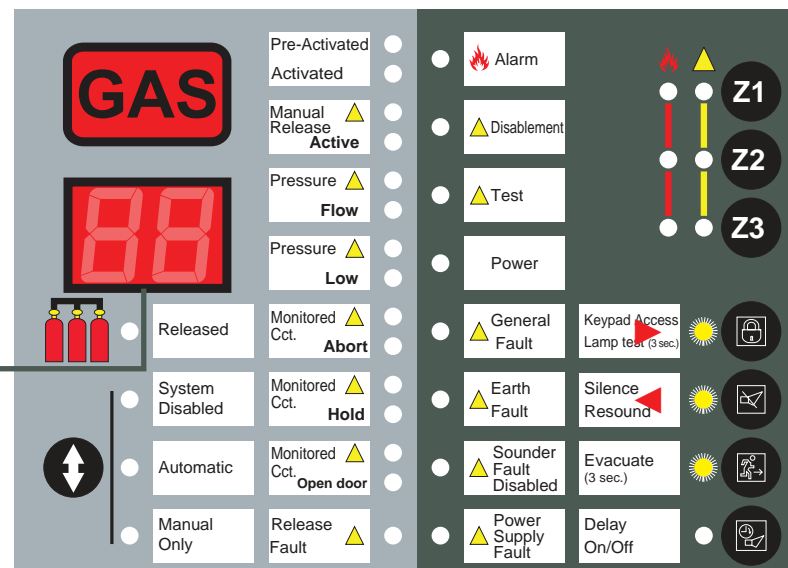

5.6.3 Monitored Parameters

The following parameters are monitored by the control panel and accessible through Monitoring mode:

	Earth leakage level	The display shows the monitored value of Earth leakage level. Leakage to negative will reduce level, while leakage to positive will increase it. Typical value: 99-100.
	Sounders circuit 1	Resistive value of sounders circuit 1 (SND1).
	Sounders circuit 2	Resistive value of sounders circuit 2 (SND2).
	Extinguishing circuit 1	Resistive value of Extinguishing circuit 1 (CCT EXT 1).
	Extinguishing circuit 2	Resistive value of Extinguishing circuit 2 (CCT EXT 2).
	Battery resistor	The displays shows the monitored value ^(*) of the battery inner resistor.



Depending on the value to be displayed the 7-segment display may be insufficient and, for this reason, the position of the dot is used for the calculation of the total value:

= 1.5 Ω

= +100 (11.5 Ω)

= +200 (21.5 Ω)

^(*) (*) In the case of the parameter corresponding to the battery inner resistor, this value should be interpreted by applying a reduction factor of 10:1. I.e:

= 0.15 Ω

= 1.15 Ω

Note: The values shown in the monitoring mode are only useful if the control panel uses diodes and capacitors for monitorin mode.

Appendix A General Wiring Diagram

- 1 Battery connection
- 2 Power supply connector
- 3 Inhibition monitoring earth jumper
- 4 USB port
- 5 Lithium battery location
- 6 Access level 3 jumper
- 7 RS-232 communication port
- 8 I²C auxiliary communication port

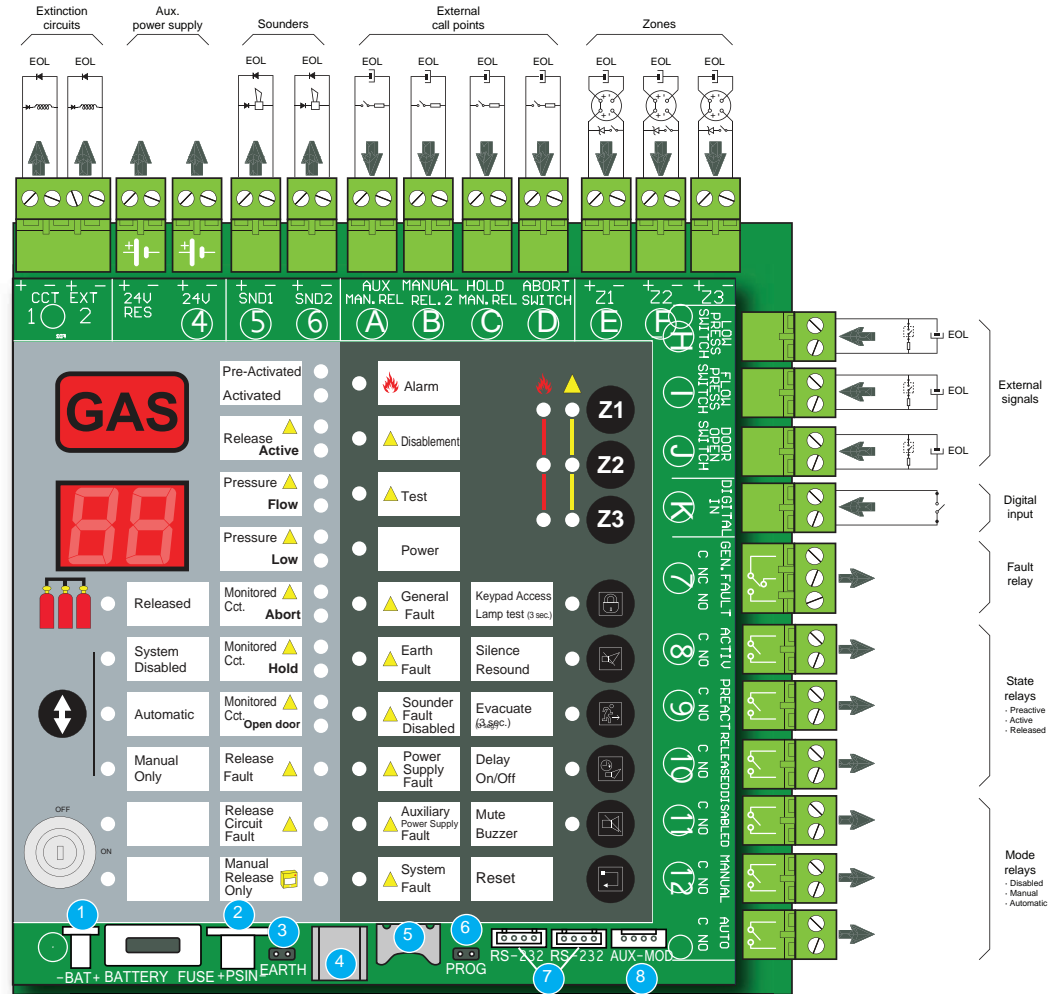

Appendix B Specifications

Mechanical

Construction:	Compact control panel with modular construction and composed of a metal mounting plate, an enclosure which supports the electronic elements and a plastic front cover.
Dimensions (H x W x D):	353 x 381 x 123mm
Weight (no batteries / with batteries):	4 Kg / 9.3 Kg
Mounting holes:	3 in metal mounting plate to fix it to the wall, 4 in enclosure
Cable entry points:	20mm apertures: 15 (top) and 8 (back)
Terminals:	All field wiring terminations are made using plug-in screw terminals capable of accepting conductor sizes between 0.5mm ² and 2.5mm ² .

Environmental

Climatic Classification:	Class A
Operating Temperature:	-5°C to +40°C (indoor)
Humidity:	Max. 95% RH, non-condensing
Panel sealing:	IP30

Controls & Indications

Display:	a) 7-segment LED Display (2 digits) for configuration and countdown timer. b) Indicator with the word "GAS" screen printed for indication of extinguishing release start.
Status indicators:	38 LEDs are provided for the following indications: Alarm, faults, status of monitored inputs and outputs, operating modes, external signals, release sequence status, silence sounders, mute buzzer.
Zone indicators:	6 zone LED indicators (2 leds per zone / 3 zones)
Controls:	10 push buttons are provided for the following functions: Disable/test zones, test LEDs, disable/enable sounders, mute buzzer, manual evacuation, sounders delay, reset, operating mode selection.
Access control:	Key to get access level 2 (keypad unlock) and internal jumper to get access level 3 (programming)
Buzzer:	Internal sounder with SPL _{min} = 60dBA at 1m

System capacity

Detection zones:	3 independent zones: <ul style="list-style-type: none">• 2 zones for conventional detectors• 1 configurable zone for detector or manual call point
Sounder circuits:	2 monitored output circuits for sounders (2 x 250 mA)
Release circuits:	2 monitored output circuits for extinguishing release devices activation (2 x 1 A)
Auxiliary relay outputs:	7 output contacts for the following functions: <ul style="list-style-type: none">• 1 general fault relay• 3 release status relays (Activated, Preactivated, In progress)• 3 operating mode relays (Disabled, Manual, Automatic)
Auxiliary input contacts:	7 monitored input circuits for the following functions: <ul style="list-style-type: none">• 2 for <i>Manual Release</i> call points connection• 1 for <i>Hold</i> device connection• 1 for <i>Abort</i> emergency device connection• 3 for technical alarm contacts (Low pressure, Flow and door open)
Digital input:	1 digital input which can be configured as NO/NC
Auxiliary 24Vdc supply:	Two 24Vdc outputs (resettable and non-resettable) to supply external devices ($I_{max} = 2 \times 250 \text{ mA}$)
Internal clock:	Internal clock RTC for event log with lithium battery (CR2016 / CR2025 or CR2032)
Event log:	Capacity: 1000 events. Accessible through software
Communication:	4 internal ports: <ul style="list-style-type: none">• 2 serial ports RS-232 (TTL, with Rx, Tx and Gnd, no hardware flow control)• 1 serial port I²C• 1 USB port (type B connector)

Electrical supply

Classification:	Installation Class 1 (the control panel must be earth)
Mains supply:	110/230 Vac $\pm 15\%$, 50/60 Hz
Max. Power:	65 W
Standby power consumption:	125 mA

Mains fuse rating:	T4AL-250V (4 A)
Backup batteries:	Emergency power supply by means of internal batteries (2 x 12V; 7Ah)
Max. Output voltage:	28Vdc \pm 100 mV
Max. Battery power:	2,4 A (65 W)
Battery load current:	300 mA
Battery resistor test (EN54):	700 m Ω
Battery fuse rating:	F4AL 250V (4 A)
Battery charger output voltage:	Max. 1 A @ 30 Vdc

Approvals

In accordance with:	UNE-EN 12094-1:2004, UNE-EN 54-2 and UNE-EN 54-4/A2:2006
CPD certification:	1134-CPD-045



Battery Disposal

As a minimum, replace the batteries every four years.

The battery units should always be disposed of in accordance with the battery manufacturer's recommendations and local regulations.

Batteries should be disposed of separately from household waste. Always dispose of batteries as per your local regulations. Again, do not dispose of batteries with normal household waste. If you have any questions, please contact the local authorities responsible for waste disposal

- Batteries should not be taken apart, thrown in the fire or short circuited.
- If a battery has leaked do not touch the battery fluid. Avoid skin contact (e.g. put on protective gloves) and clean the battery compartment with a dry cloth.
- Always replace all batteries at the same time and use batteries of the same type. Extreme care must be taken to avoid damage from electricity. Use appropriate tools with insulated handles.

Appendix C Accessories

RP1r-Supra	Extinguishing control panel
VSN-232	RS-232 communication module
TG-IP-1	IP communication module (VSN-232 required)
VSN-4REL	4-relay module
ITAC	Interface module for RP1r-Supra integration into an ID system
TG-RP1r	Graphic management software for RP1r-Supra control panel
OPC-RP1r	Software based on OPC server standard which meets the Data Access 1.0 and 2.0 protocol. The OPC-RP1r software is designed for the integration of Notifier Extinguishing control panels (RP1r series) in any managing system or SCADA with OPC requirements
UCIP	IP-GPRS communication module (VSN-232 is required)

Honeywell Life Safety Iberia

C/ Pau Vila, 15-19; 08911 Badalona (Barcelona)

T. 902 03 05 45 - F. 93 465 86 35

www.honeywelllifesafety.es

The Honeywell logo is displayed in a bold, red, sans-serif font. The letters are thick and closely spaced, with a distinctive 'y' that has a rounded bottom. The logo is positioned in the bottom right corner of the page.